



Residential Sprinkler Wall Wetting Patterns

The wall wetting patterns presented in this bulletin illustrate the general wall areas wetted by Reliable residential sprinklers under the test conditions. Tests were conducted under a smooth, flat, horizontal ceiling without obstructions or vents. Variations from the test conditions may impact the wall wetting pattern produced by the sprinkler. The graphs provide an estimate of the wall wetting pattern produced during the test and are not a guarantee of performance under specific installation conditions. Reliable residential sprinklers are listed for compliance with UL 1626, which includes requirements for wall wetting under prescribed test conditions.

Reliable residential sprinklers are listed for installation in accordance with NFPA 13, NFPA 13R, or NFPA 13D. In addition, national or local codes and standards may include additional requirements for sprinkler system installation. Wall wetting patterns are provided for information only and do not modify requirements to comply with all applicable codes and standards, including NFPA 13, NFPA 13R, and NFPA 13D.

TABLE OF CONTENTS

1. F1 Res 30 Pendant and Recessed Pendant

- 1-1 12ft x 12ft, 14ft x 14ft coverage area
- 1-2 16ft x 16ft coverage area

2. F1 Res 30 CCP & F1Res 30 Recessed Pendant/FP

- 2-1 12ft x 12ft, 14ft x 14ft coverage area

3. F1 Res 49 Pendant and Recessed Pendant

- 3-1 12ft x 12ft, 14ft x 14ft coverage area
- 3-2 16ft x 16ft, 18ft x 18ft, 20ft x 20ft coverage area

4. F1 Res 49 CCP & F1 Res 49 Recessed Pendant/ FP

- 4-1 12ft x 12ft, 14ft x 14ft coverage area
- 4-2 16ft x 16ft, 18ft x 18ft, 20ft x 20ft coverage area

5. F1 Res 58 Pendant and Recessed Pendant

- 5-1 12ft x 12ft, 14ft x 14ft, 16ft x 16ft coverage area
- 5-2 18ft x 18ft, 20ft x 20ft coverage area

6. F1 Res 58 CCP & F1 Res 58 Recessed Pendant/FP

- 6-1 12ft x 12ft, 14ft x 14ft coverage area
- 6-2 16ft x 16ft, 18ft x 18ft, 20ft x 20ft coverage area

7. F1 Res 76 Pendant and Recessed Pendant

- 7-1 18ft x 18ft, 20ft x 20ft coverage area

8. F1 Res 76 CCP Pendant

- 8-1 16ft x 16ft, 18ft x 18ft, 20ft x 20ft coverage area

9. F1 Res 44 Hsw & F1 Res 44 Recessed HSW/F2

- 9-1 16ft x 20ft, 16ft x 18ft coverage area (4" - 6" deflector to ceiling distance)
- 9-2 18ft x 18ft, 16ft x 16ft, 14ft x 14ft coverage area (4" - 6" deflector to ceiling distance)
- 9-3 12ft x 12ft coverage area (4" - 6" deflector to ceiling distance)
12ft x 12ft, 14ft x 14ft coverage area (6" - 12" deflector to ceiling distance)
- 9-4 16ft x 16ft, 16ft x 18ft, 16ft x 20ft coverage area (6" - 12" deflector to ceiling distance)

10. F1 Res 58 HSW & Recessed HSW/F2

- 10-1 12ft x 12ft, 14ft x 14ft, 16ft x 16ft coverage area (4" - 6" deflector to ceiling distance)
- 10-2 16ft x 18ft, 16ft x 20ft coverage area (4" - 6" deflector to ceiling distance)
- 10-3 12ft x 12ft, 14ft x 14ft coverage area (6" - 12" deflector to ceiling distance)
- 10-4 16ft x 16ft, 16ft x 18ft coverage area (6" - 12" deflector to ceiling distance)

11. F1 Res 58 HSWX & Recessed HSWX/F2

- 11-1 18ft x 20ft, 20ft x 20ft coverage area (4" - 6" deflector to ceiling distance)
- 11-2 16ft x 22ft, 16ft x 24ft, 14ft x 26ft coverage area (4" - 6" deflector to ceiling distance)
- 11-3 18ft x 20ft, 16ft x 22ft coverage area (6" - 12" deflector to ceiling distance)
- 11-4 16ft x 24ft, 14ft x 26ft coverage area (6" - 12" deflector to ceiling distance)

12. RFC 30 Flat Concealed Pendant

- 12-1 12ft x 12ft, 14ft x 14ft coverage area

13. RFC 43 Flat Concealed Pendent

- 13-1 12ft x 12ft, 14ft x 14ft coverage area
- 13-2 16ft x 16ft, 18ft x 18ft, 20ft x 20ft coverage area

14. RFC 49 Flat Concealed Sprinkler

- 14-1 12ft x 12ft, 14ft x 14ft coverage area
- 14-2 16ft x 16ft, 18ft x 18ft, 20ft x 20ft coverage area

15. RFC 56 Flat Concealed Pendent

- 15-1 16ft x 16ft coverage area

16. RFS 42 Flat HSW

- 16-1 12ft x 12ft, 14ft x 14ft coverage area (4" - 6" deflector to ceiling distance)
- 16-2 16ft x 16ft, 16ft x 18ft, 16ft x 20ft coverage area (4" - 6" deflector to ceiling distance)
- 16-3 12ft x 12ft, 14ft x 14ft, 16ft x 20ft coverage area (6" - 12" deflector to ceiling distance)
- 16-4 16ft x 16ft, 16ft x 18ft coverage area (6" - 12" deflector to ceiling distance)

F1 Res 30 Pendent & Recessed Pendent Wetting Patterns:

F1 Res 30 Pendent



F1 Res 30 Recessed Pendent /F1

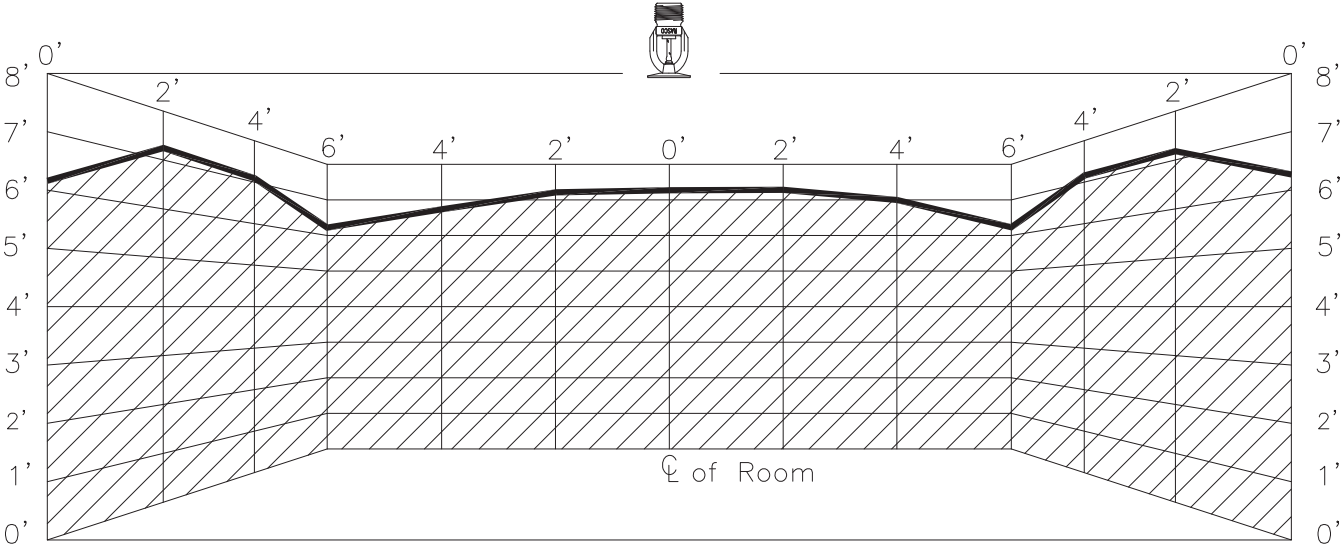

F1 RES30-PEND-12

F1 RES30 Pendent
12x12 COVERAGE AREA

8 GPM

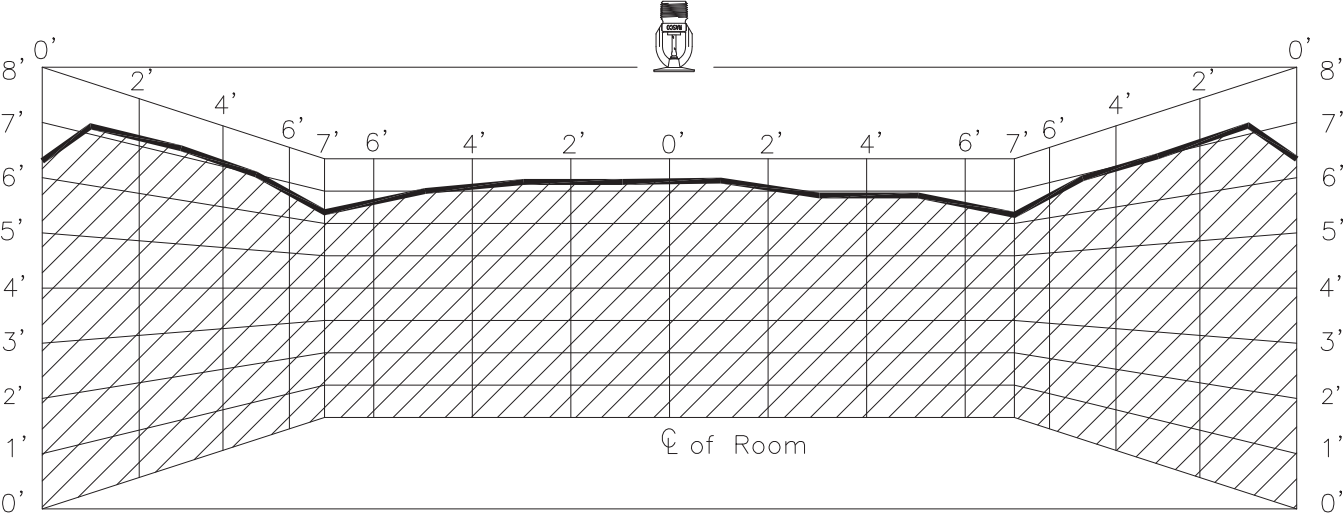

F1 RES30-PEND-14

F1 RES30 Pendent
14x14 COVERAGE AREA

10 GPM

F1 Res 30 Pendent & Recessed Pendent Wetting Patterns (cont.):

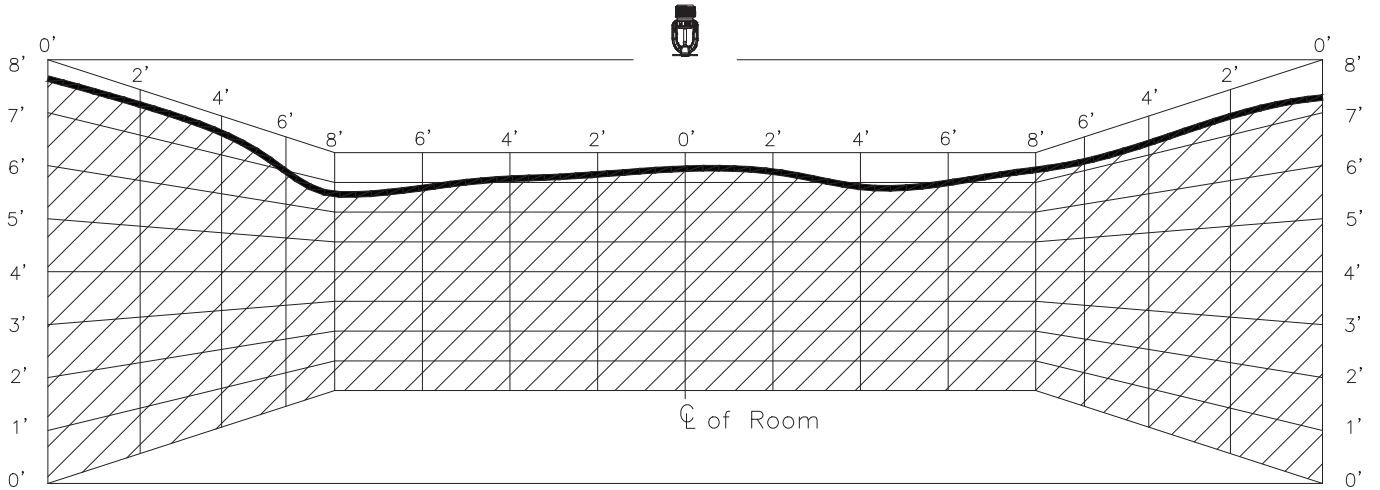

F1RES30-PEND-16

NOMINAL WETTING PATTERN
16ft.x16ft. COVERAGE AREA

1.3 GPM

F1 Res 30 CCP & F1 Res 30 Recessed Pendant/FP Wetting Patterns:

F1 Res 30 CCP



F1 Res 30 Recessed Pendant /FP

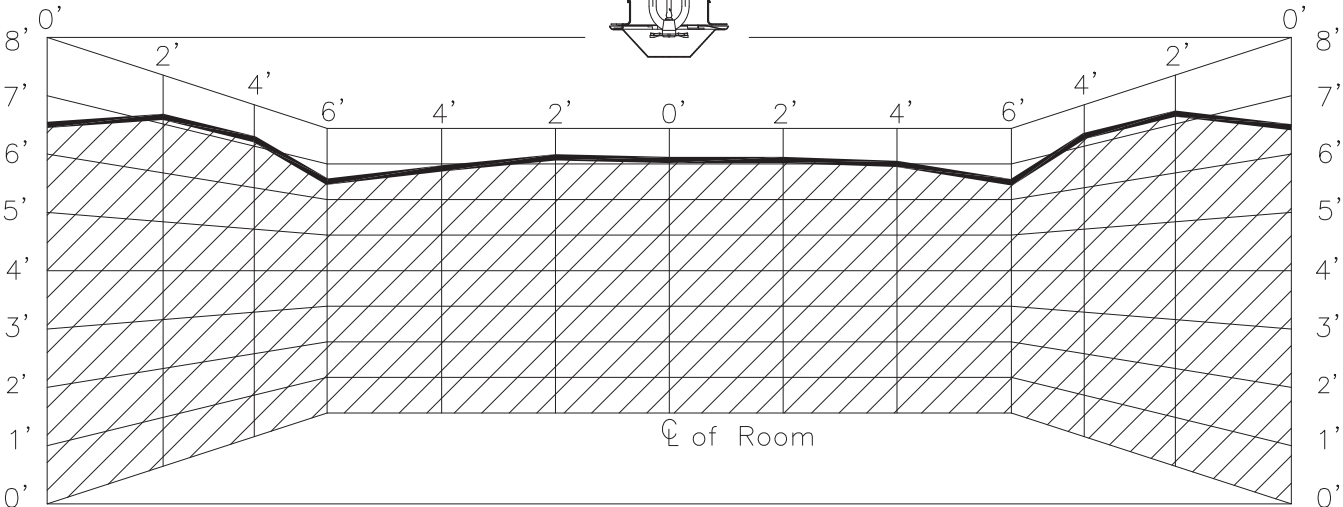
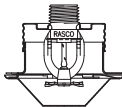

F1 RES30 CCP PEND-12 12x12 COVERAGE AREA 8 GPM

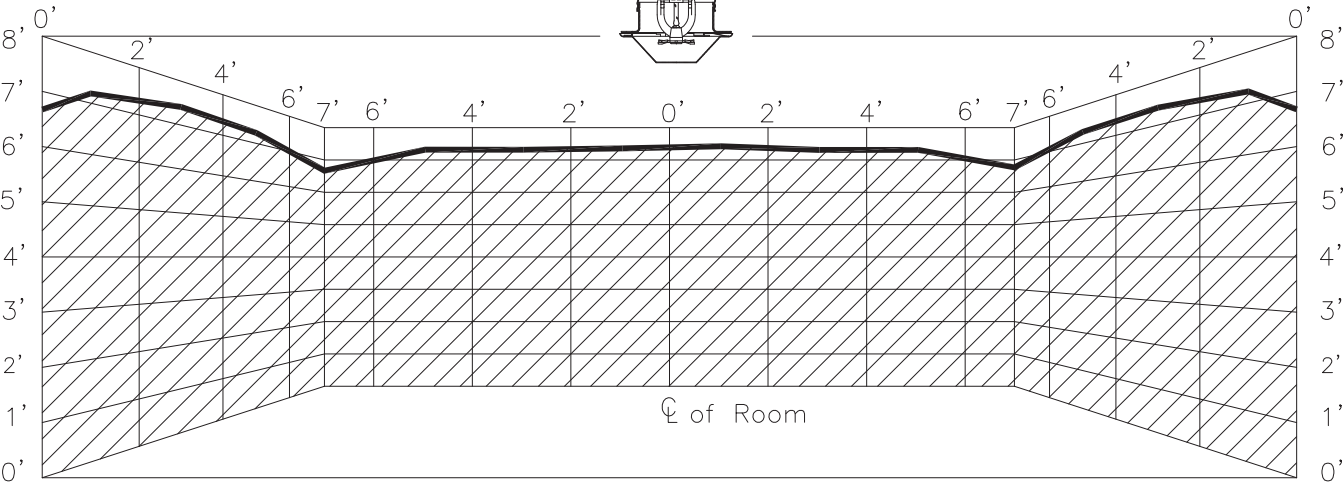
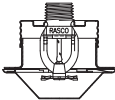

F1 RES30 CCP PEND-14 14x14 COVERAGE AREA 11 GPM

F1 Res 49 Pendant & Recessed Pendant Wetting Patterns:

F1 Res 49 Pendant



F1 Res 49 Recessed Pendant /F1

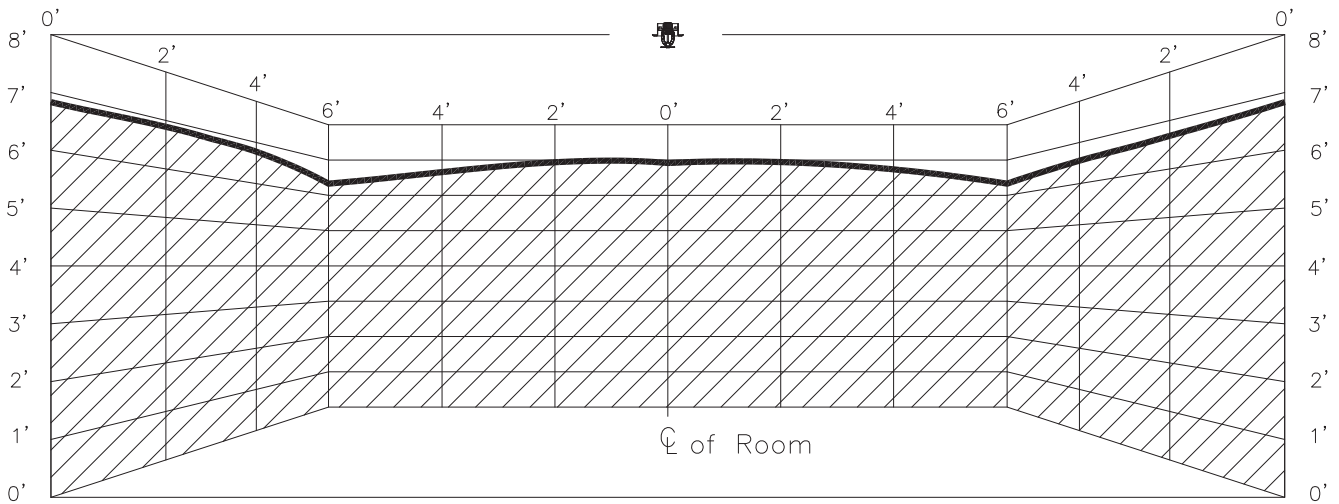

F1RES49_PEND-12

NOMINAL WETTING PATTERN
12ft.x12ft. COVERAGE AREA (Or less)

1.3 GPM

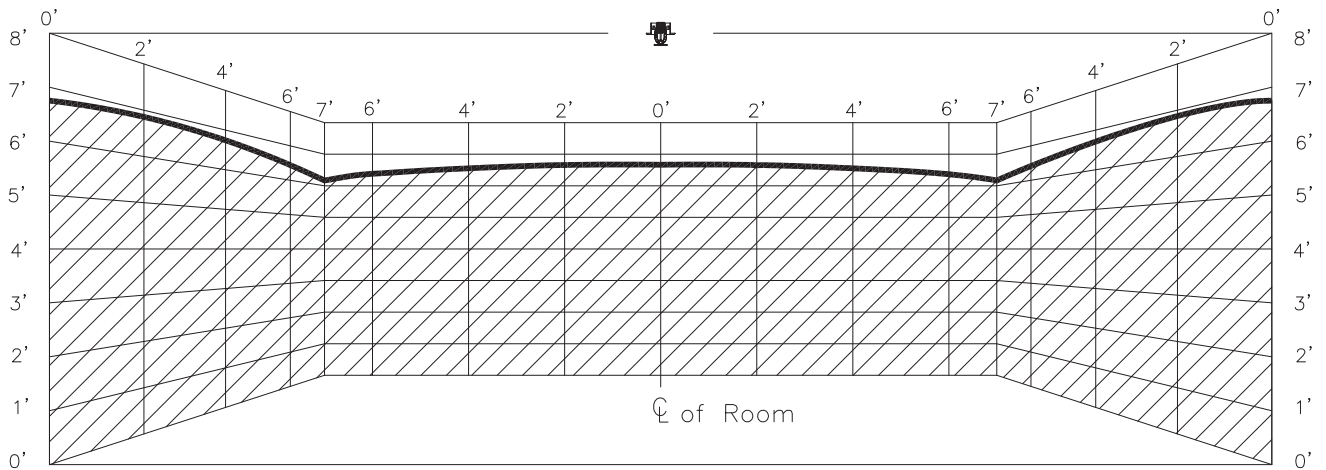

F1RES49_PEND-14

NOMINAL WETTING PATTERN
14ft.x14ft. COVERAGE AREA

1.3 GPM

F1 Res 49 Pendent & Recessed Pendent Wetting Patterns (cont.):

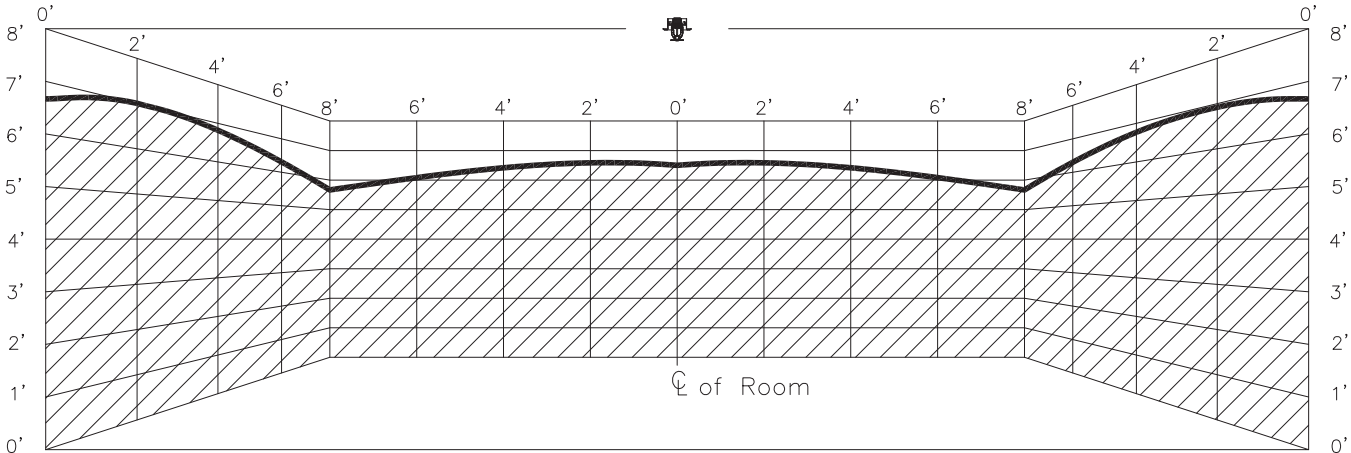

F1RES49_PEND-16

NOMINAL WETTING PATTERN
16ft.x16ft. COVERAGE AREA

1.3 GPM

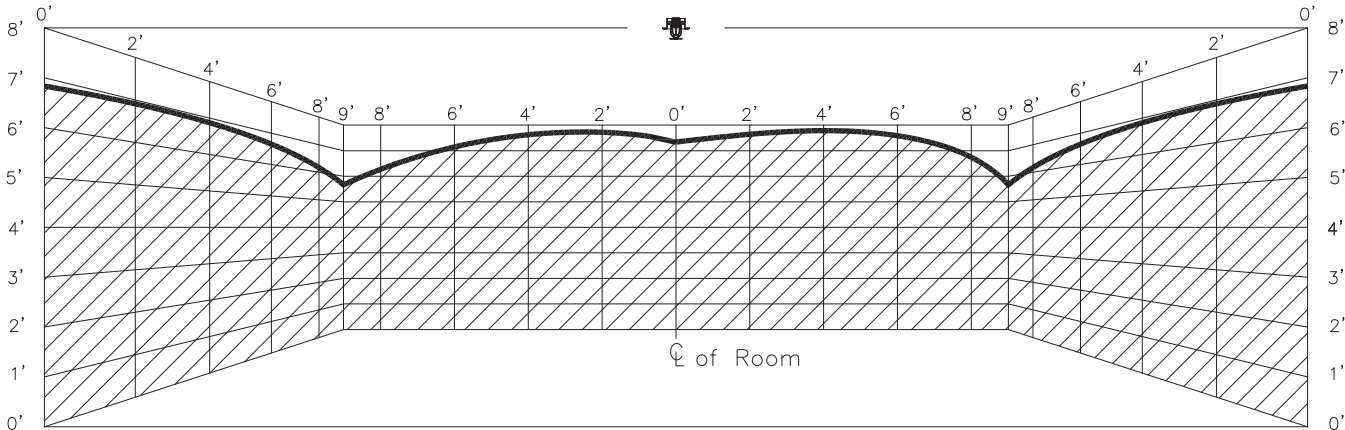

F1RES49_PEND-18

NOMINAL WETTING PATTERN
18ft.x18ft. COVERAGE AREA

17 GPM

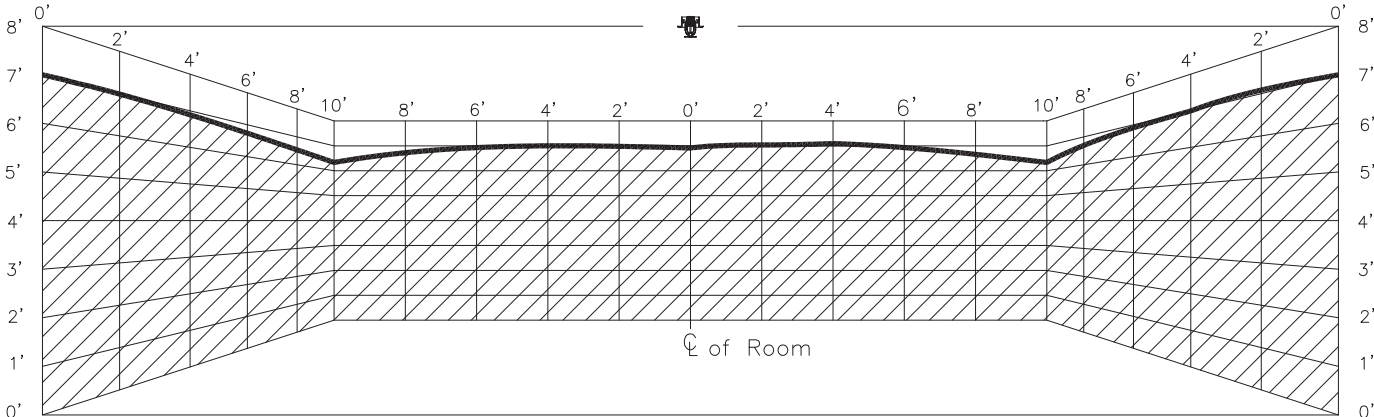

F1RES49_PEND-20

NOMINAL WETTING PATTERN
20ft.x20ft. COVERAGE AREA

20 GPM

F1 Res 49 CCP & F1 Res 49 Recessed/FP Wetting Patterns:

F1 Res 49 CCP
Pendent



F1 Res 49 Recessed
Pendent /FP

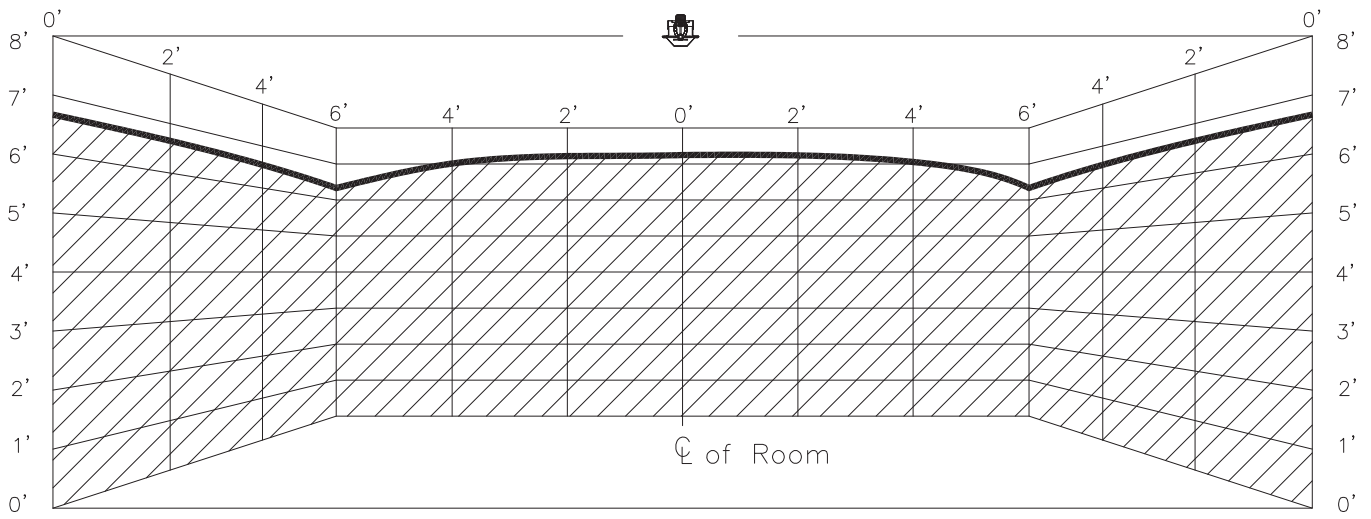

F1RES49_CCP-12

NOMINAL WETTING PATTERN
12ft.x12ft. COVERAGE AREA (Or less)

13 GPM

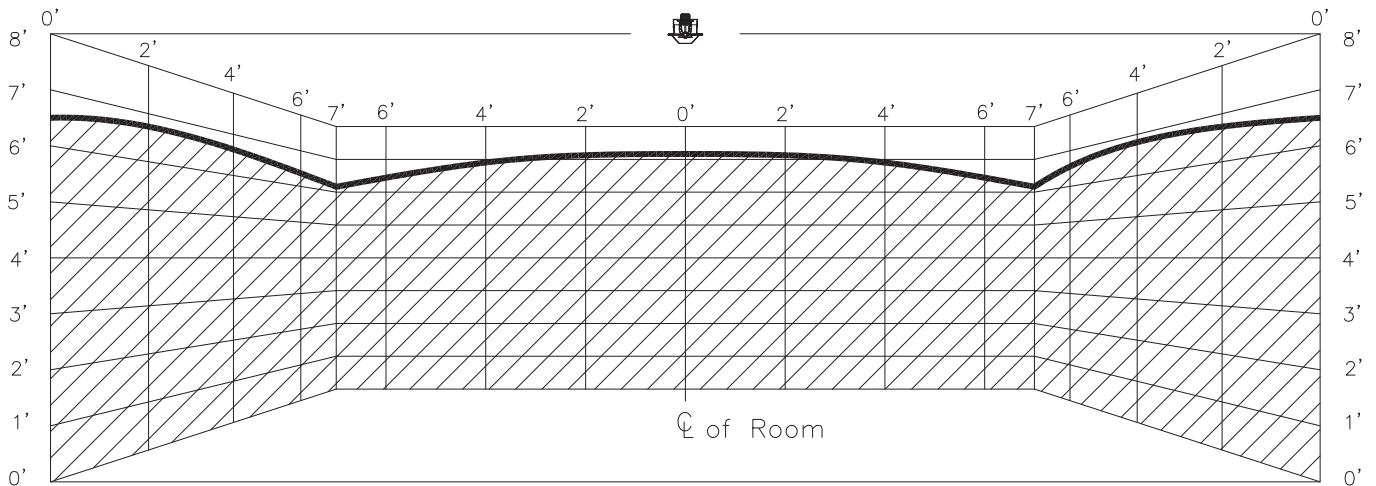

F1RES49_CCP-14

NOMINAL WETTING PATTERN
14ft.x14ft. COVERAGE AREA

13 GPM

F1 Res 49 CCP & F1 Res 49 Recessed/FP Wetting Patterns (cont.):

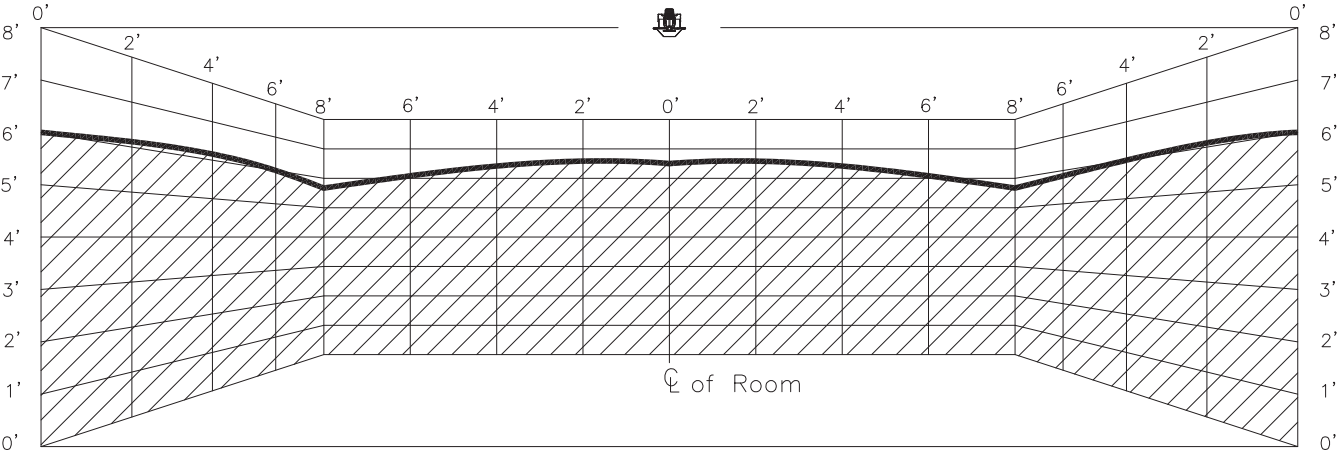

F1RES49_CCP-16

NOMINAL WETTING PATTERN
16ft.x16ft. COVERAGE AREA

14 GPM

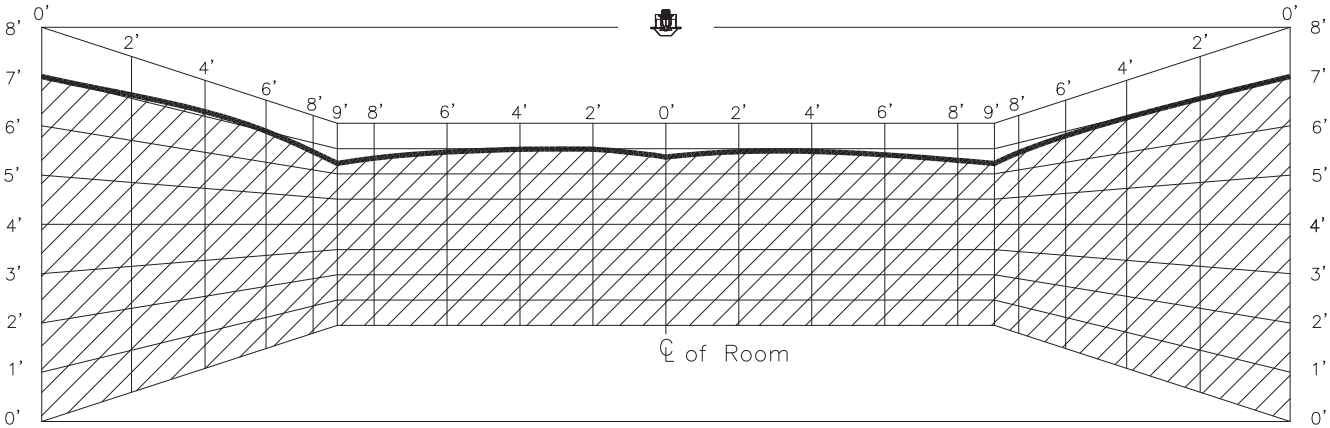

F1RES49_CCP-18

NOMINAL WETTING PATTERN
18ft.x18ft. COVERAGE AREA

18 GPM

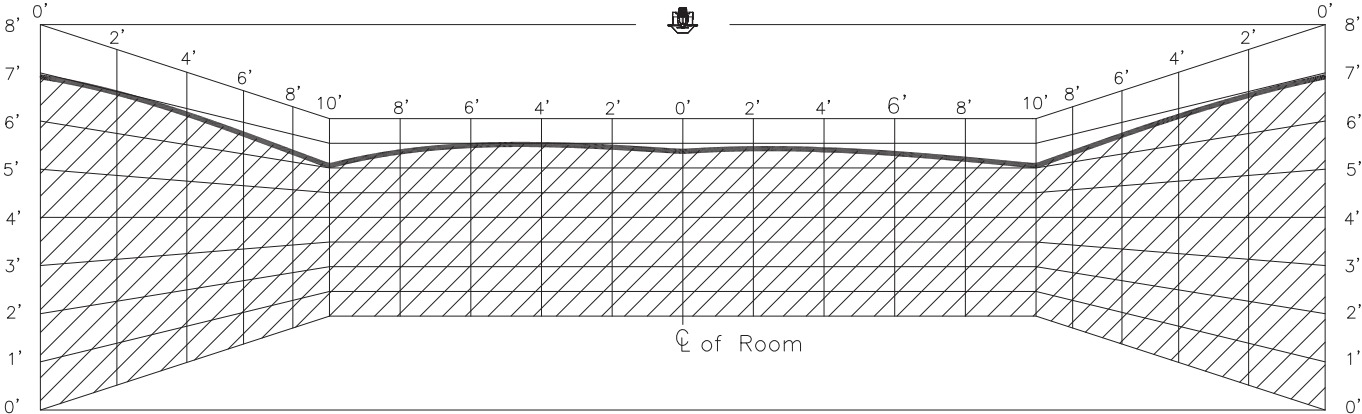

F1RES49_CCP-20

NOMINAL WETTING PATTERN
20ft.x20ft. COVERAGE AREA

20 GPM

F1 Res 58 Pendant and Recessed Pendant:

F1 Res 58 Pendant



F1 Res 58 Recessed Pendant /F1

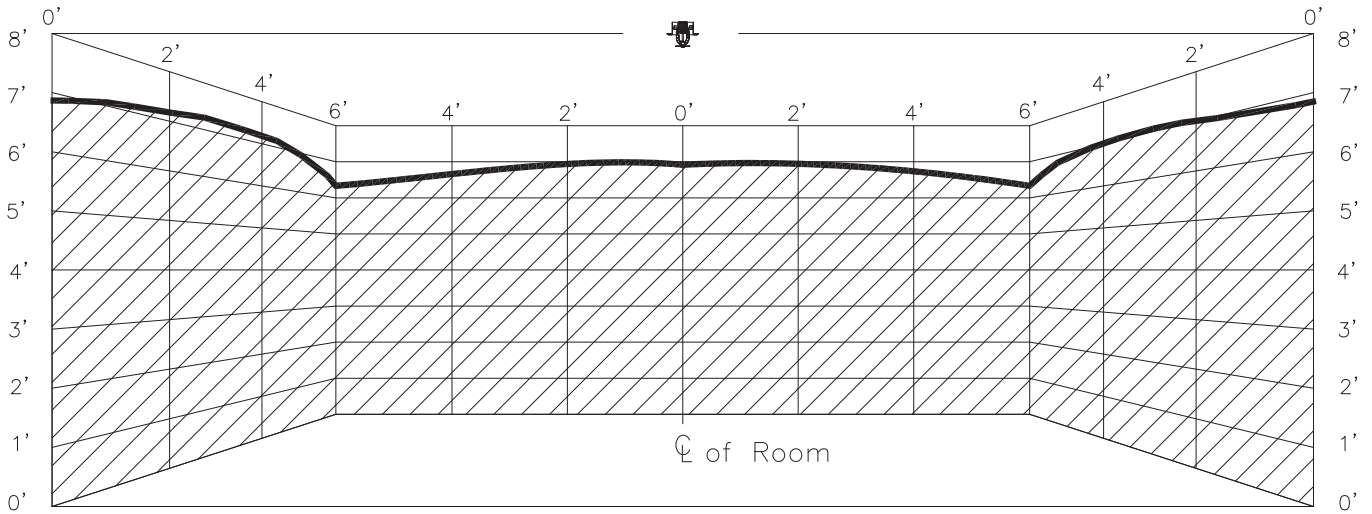

F1RES58PEND-12

NOMINAL WETTING PATTERN
12ft.x12ft. COVERAGE AREA (Or less)

16 GPM

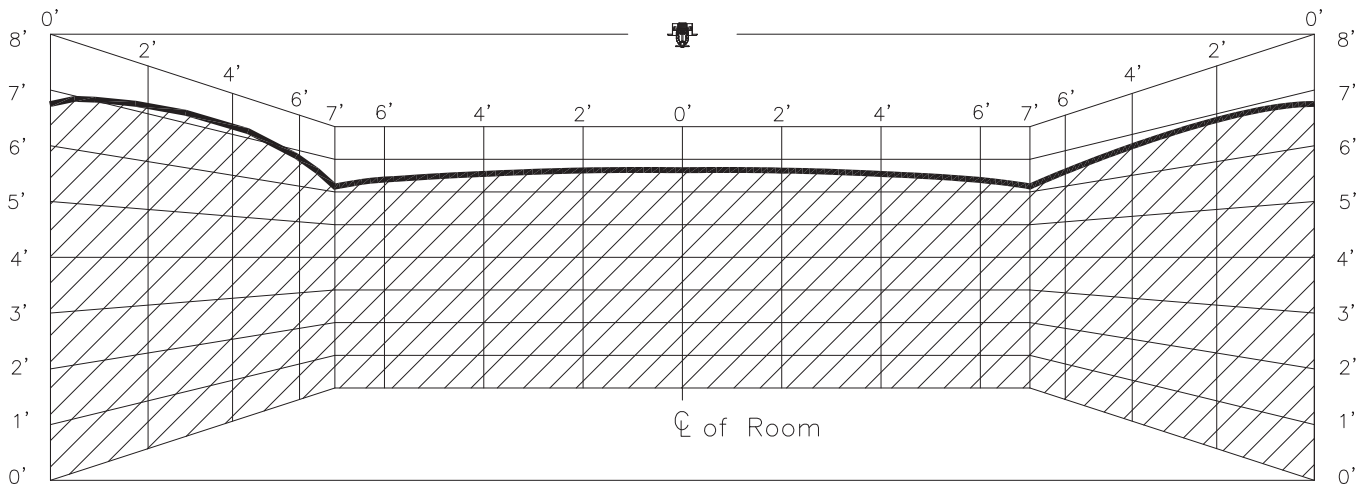

F1RES58PEND-14

NOMINAL WETTING PATTERN
14ft.x14ft. COVERAGE AREA

16 GPM

F1 Res 58 Pendent and Recessed Pendent (cont.):

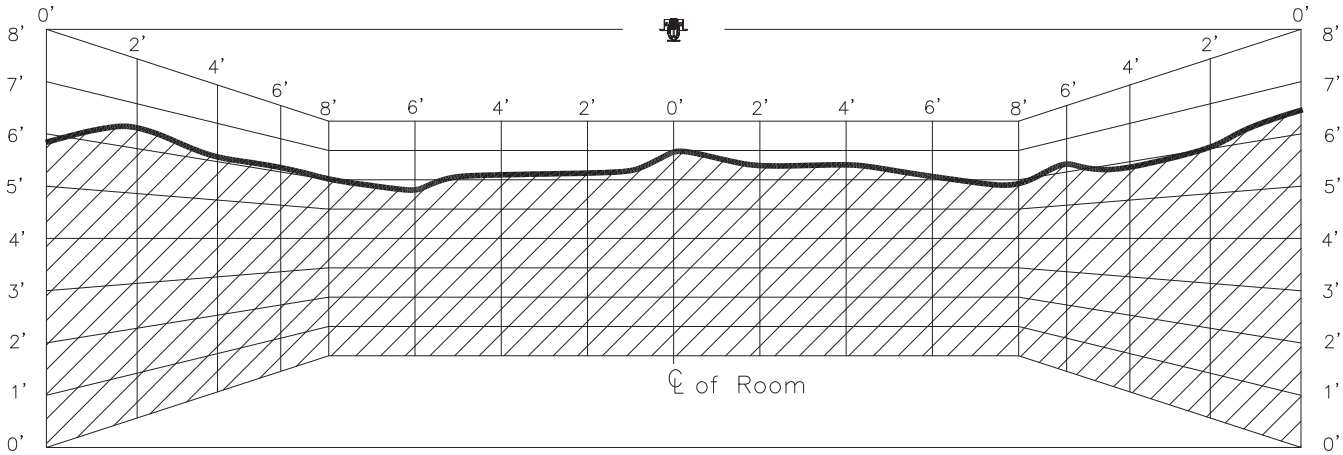

F1RES58PEND-16

NOMINAL WETTING PATTERN
16ft.x16ft. COVERAGE AREA

16 GPM

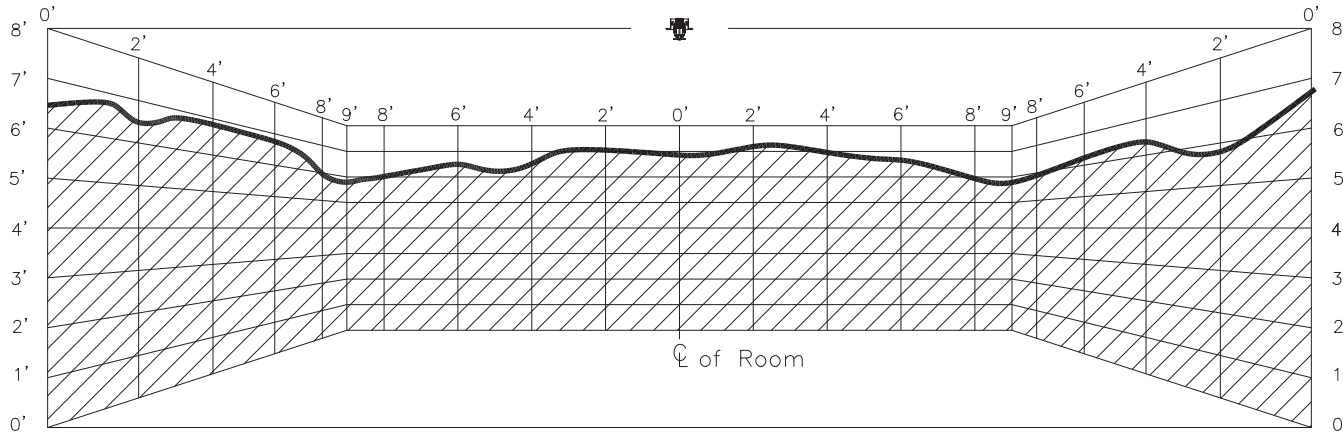

F1RES58PEND-18

NOMINAL WETTING PATTERN
18ft.x18ft. COVERAGE AREA

18 GPM

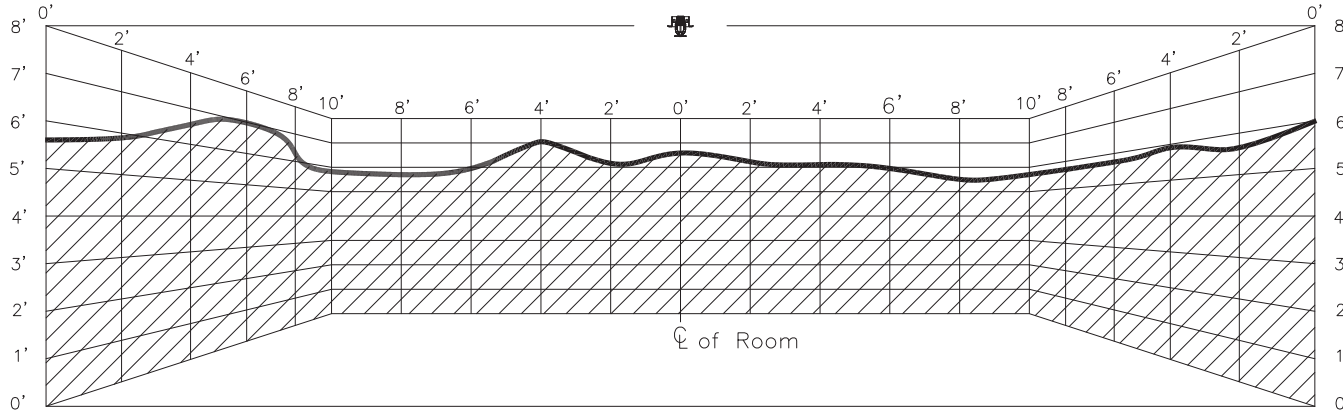

F1RES58PEND-20

NOMINAL WETTING PATTERN
20ft.x20ft. COVERAGE AREA

20 GPM

F1 Res 58 CCP & F1 Res 58 Recessed Pendant /FP:

F1 Res 58 CCP



F1 Res 58 Recessed Pendant /FP

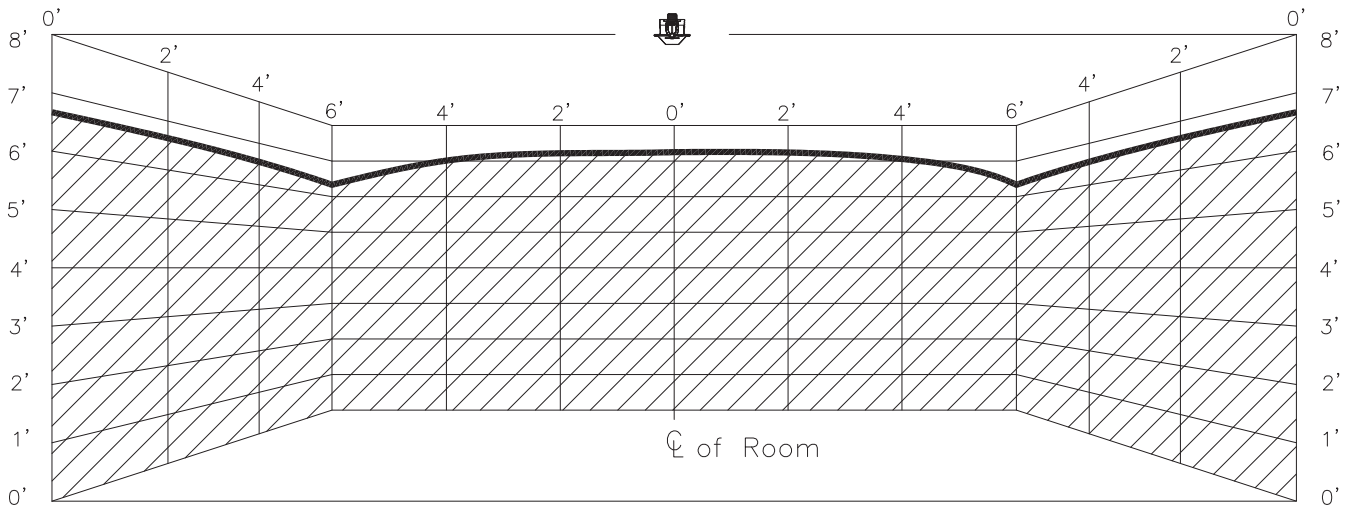

F1RES58_CCP-12

NOMINAL WETTING PATTERN
12ft.x12ft. COVERAGE AREA (Or less)

16 GPM

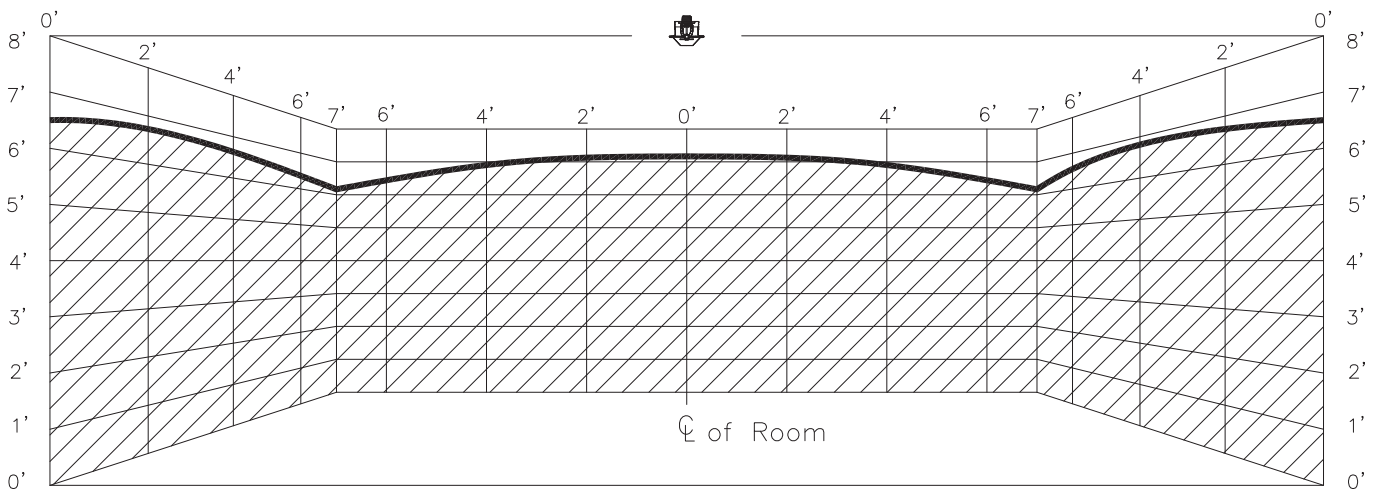

F1RES58_CCP-14

NOMINAL WETTING PATTERN
14ft.x14ft. COVERAGE AREA

16 GPM

F1 Res 58 CCP & F1 Res 58 Recessed Pendant /FP (cont.):

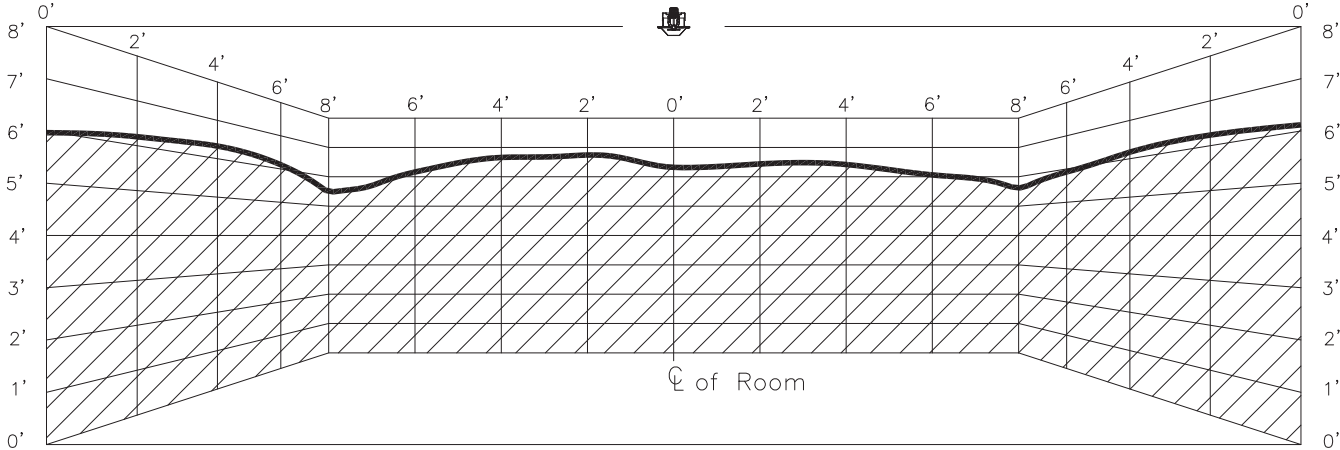

F1RES58_CCP-16

NOMINAL WETTING PATTERN
16ft.x16ft. COVERAGE AREA

16 GPM

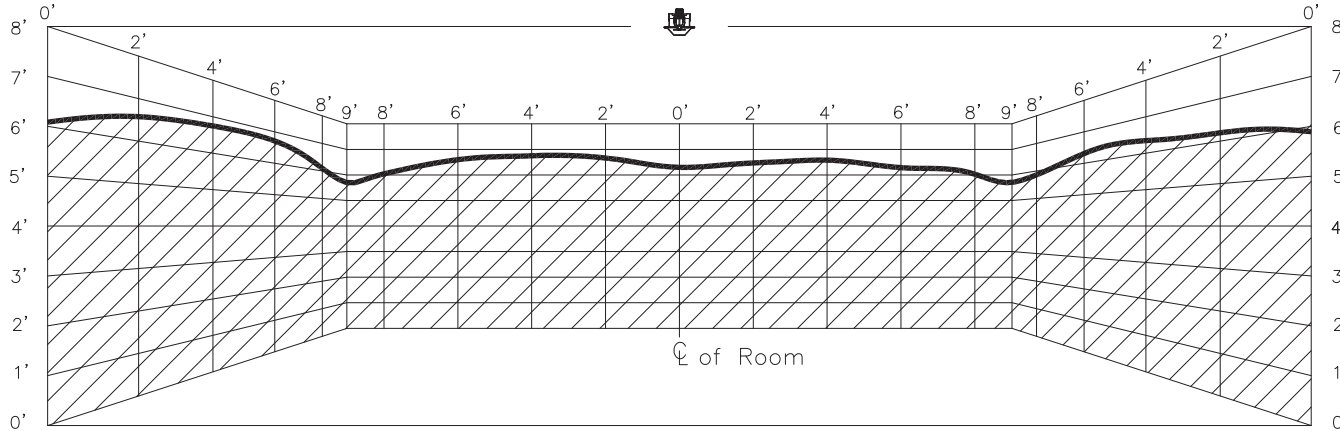

F1RES58_CCP-18

NOMINAL WETTING PATTERN
18ft.x18ft. COVERAGE AREA

19 GPM

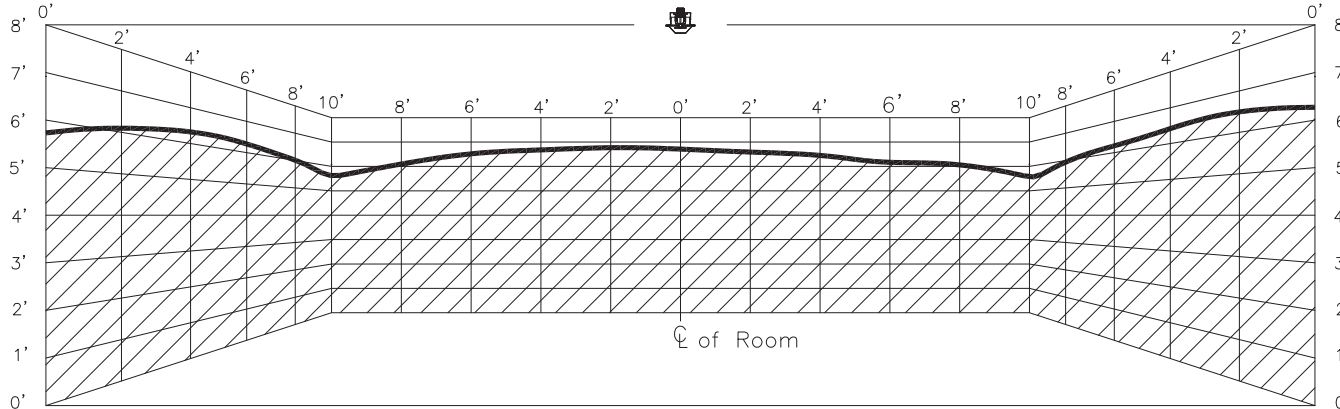

F1RES58_CCP-20

NOMINAL WETTING PATTERN
20ft.x20ft. COVERAGE AREA

22 GPM

F1 Res 76 Pendant & Recessed Pendant:

F1 Res 76 Pendant



F1 Res 76 Recessed Pendant

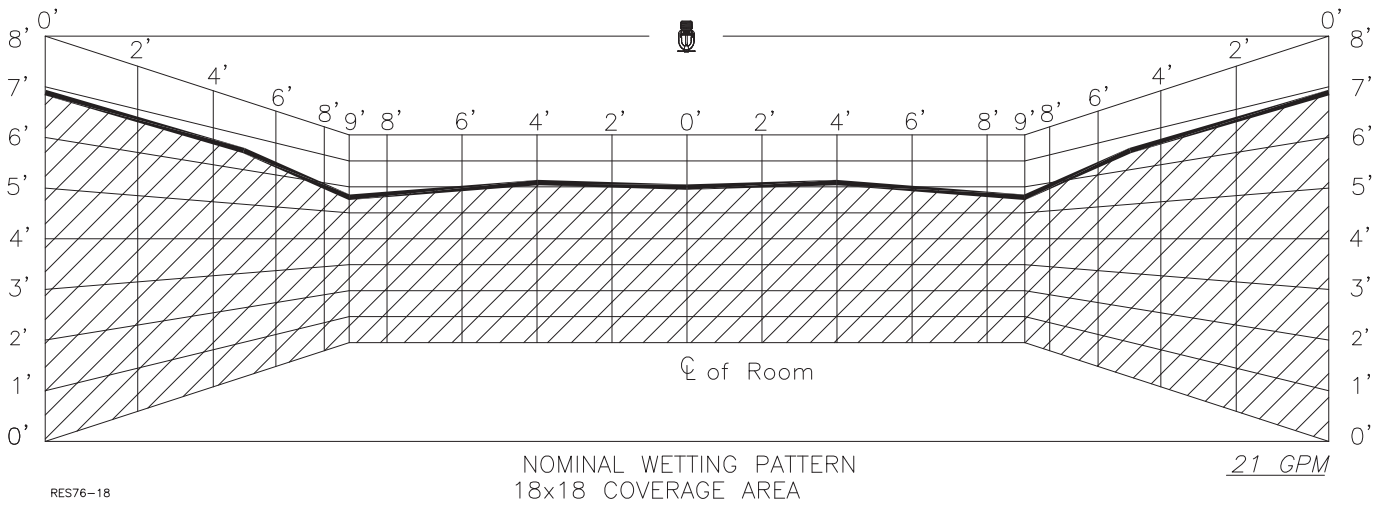

SPRINKLER DISTRIBUTION PATTERN

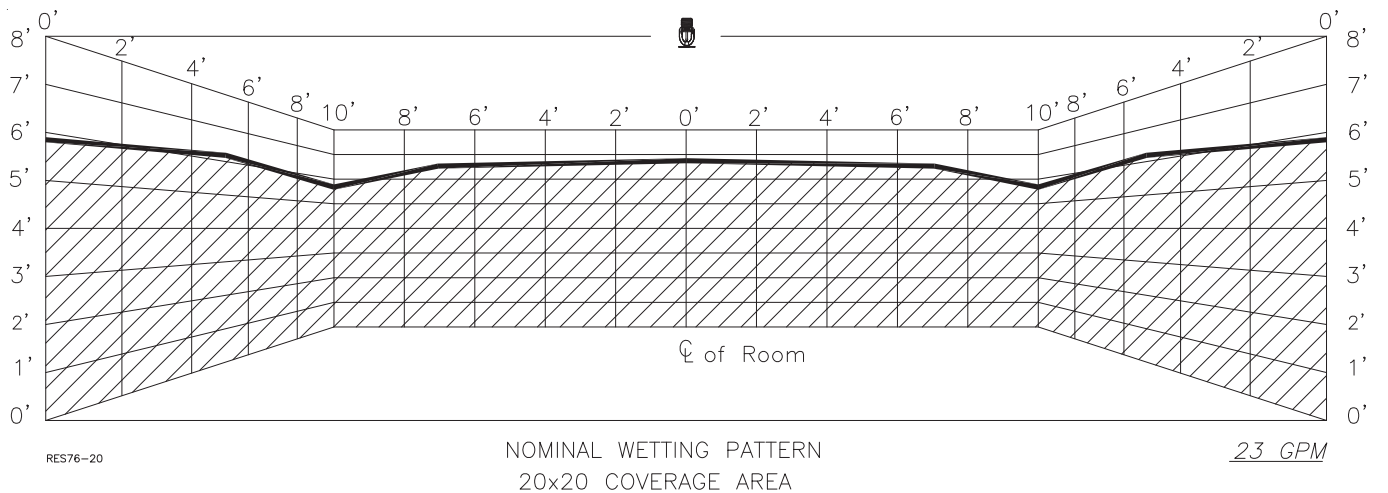

F1Res 76 CCP Pendent:

F1 Res 76 CCP Pendent

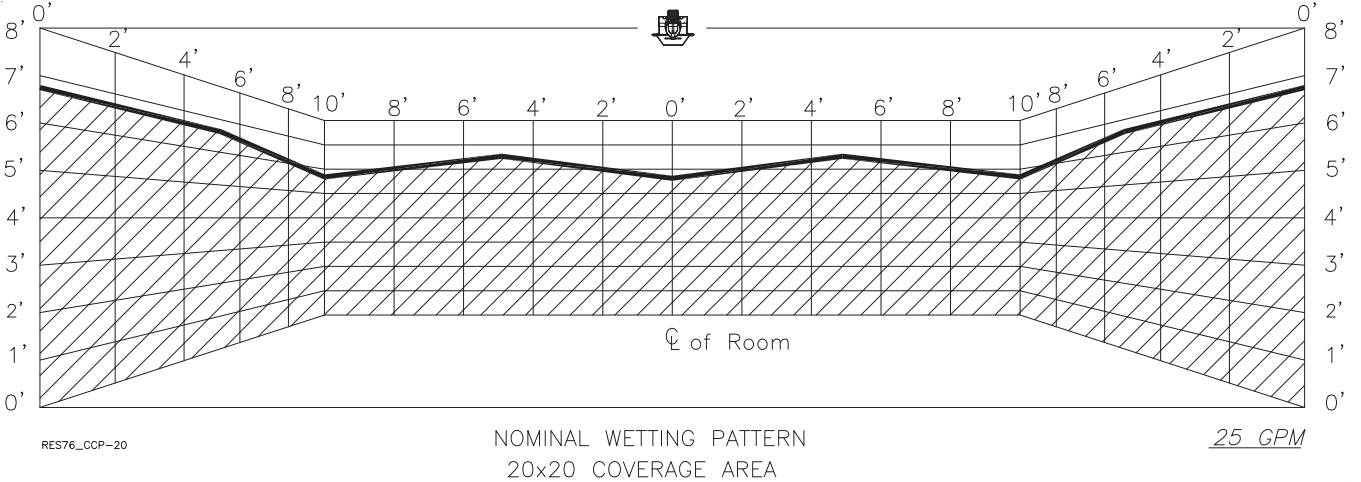
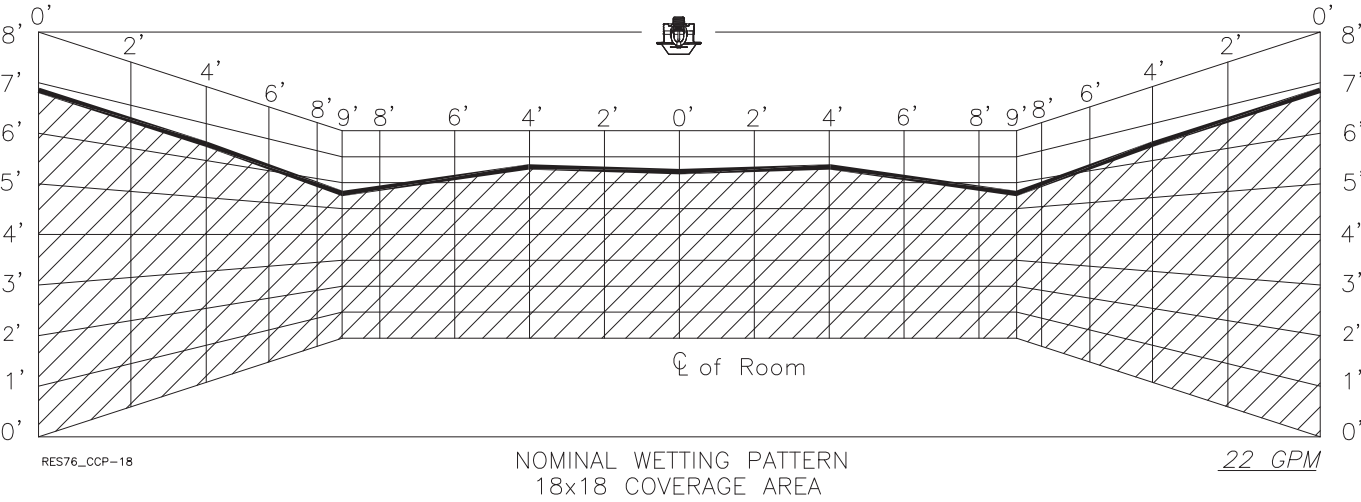
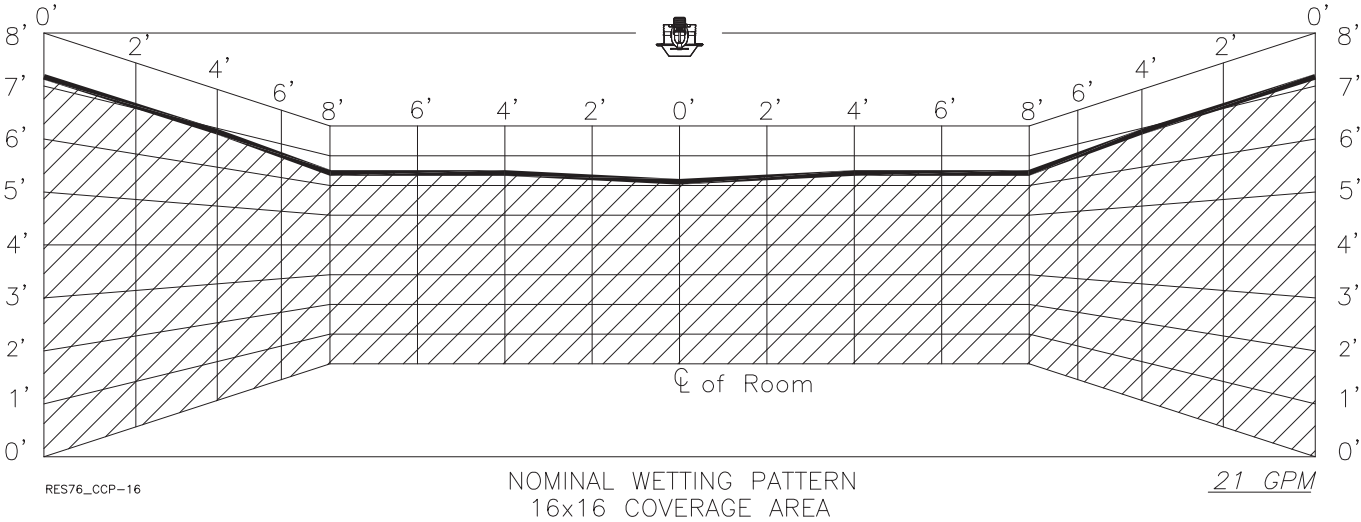
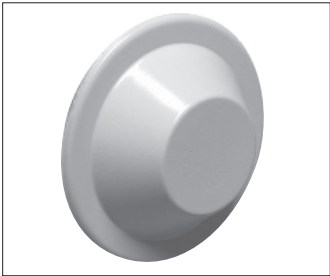

F1 Res 44 HSW & F1 Res 44 Recessed HSW/F2 Wetting Patterns:

F1 Res 44 HSW

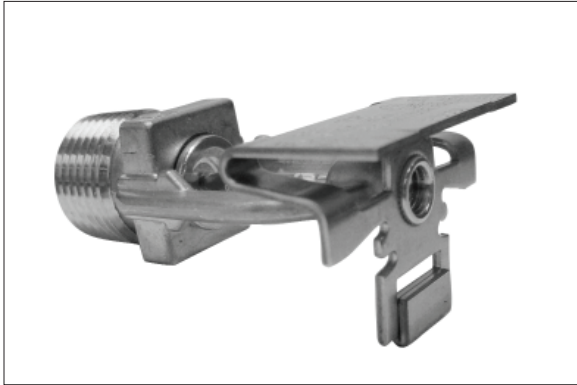

F1 Res 44 Recessed HSW/F2

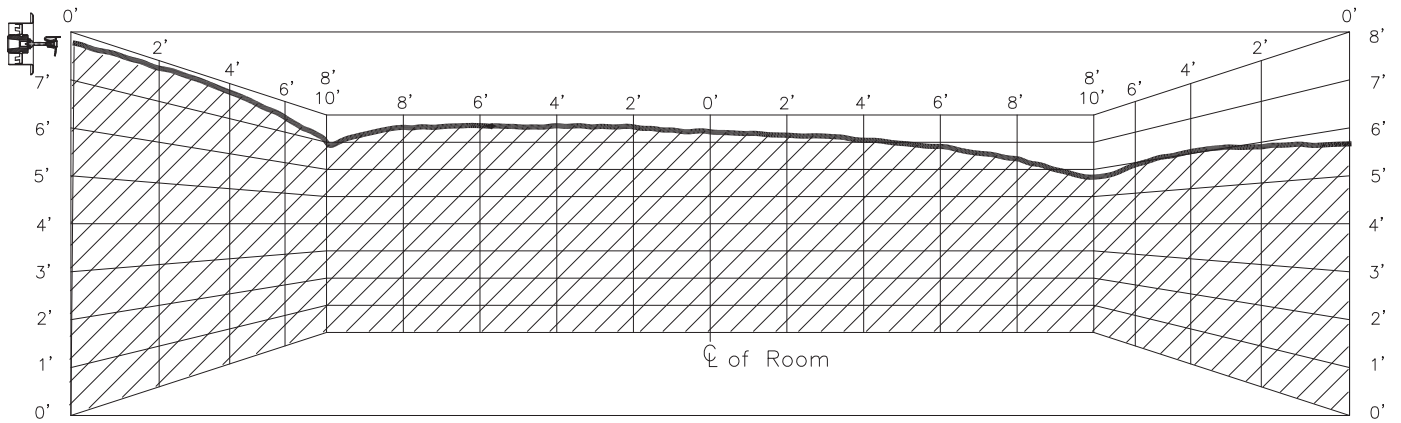

F1RES44_HSW-16x20-4

NOMINAL WETTING PATTERN
16ft.x20ft. COVERAGE AREA
4"-6" DEFLECTOR TO CEILING DISTANCE

23 GPM

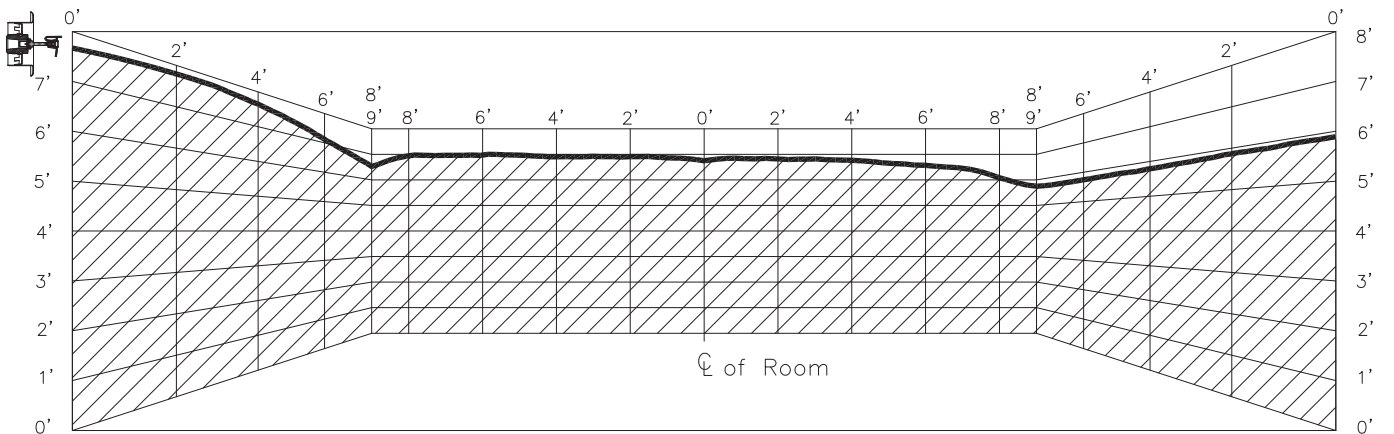

F1RES44_HSW-16x18-4

NOMINAL WETTING PATTERN
16ft.x18ft. COVERAGE AREA
4"-6" DEFLECTOR TO CEILING DISTANCE

18 GPM

F1 Res 44 HSW & F1 Res 44 Recessed HSW/F2 Wetting Patterns (cont.):

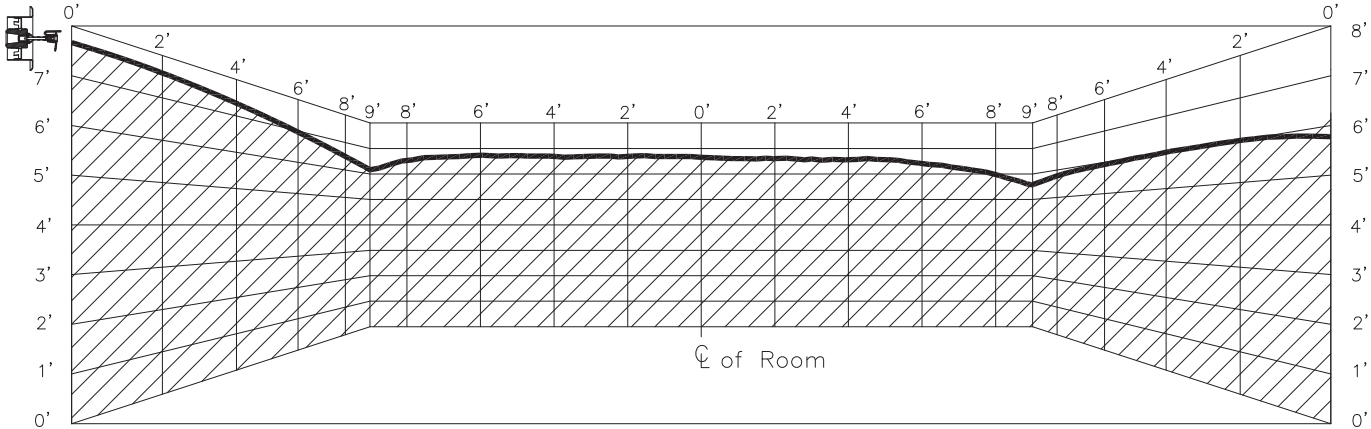

F1RES44_HSW-18x18-4

NOMINAL WETTING PATTERN
18ft.x18ft. COVERAGE AREA
4"-6" DEFLECTOR TO CEILING DISTANCE

19 GPM

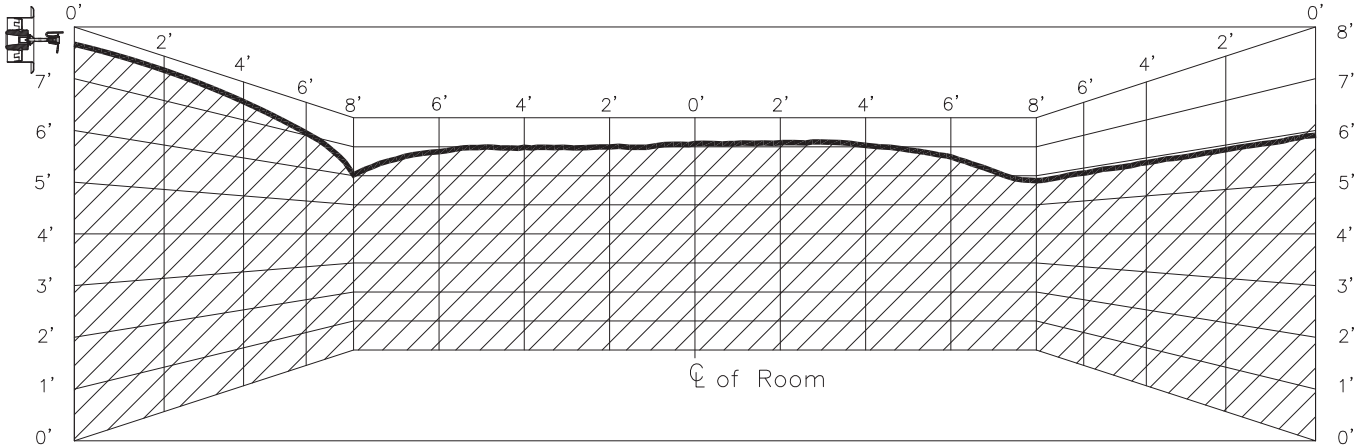

F1RES44_HSW-16x16-4

NOMINAL WETTING PATTERN
16ft.x16ft. COVERAGE AREA
4"-6" DEFLECTOR TO CEILING DISTANCE

16 GPM

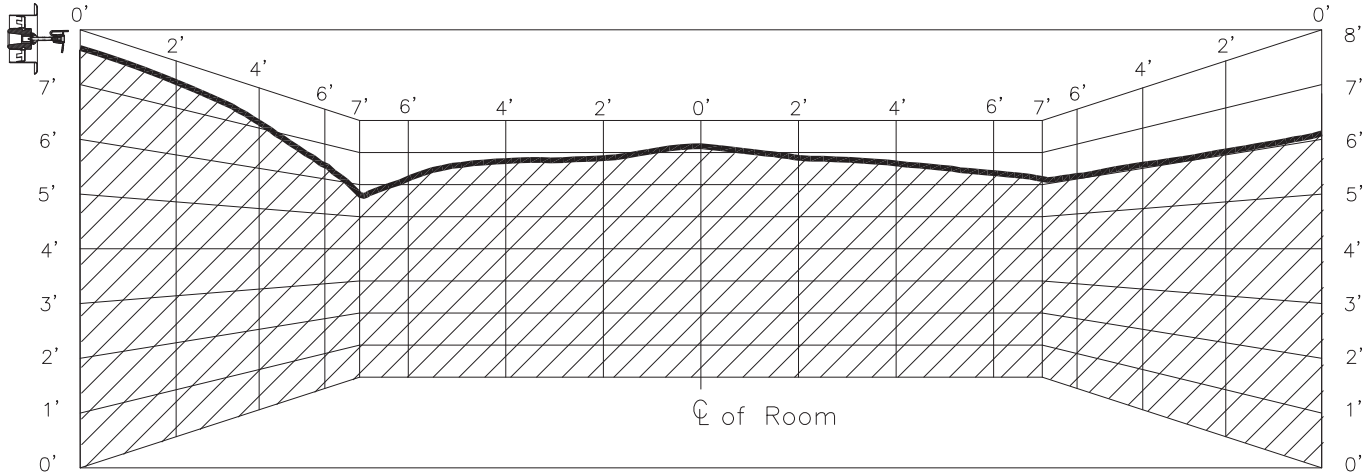

F1RES44_HSW-14x14-4

NOMINAL WETTING PATTERN
14ft.x14ft. COVERAGE AREA
4"-6" DEFLECTOR TO CEILING DISTANCE

14 GPM

F1 Res 44 HSW & F1 Res 44 Recessed HSW/F2 Wetting Patterns (cont.):

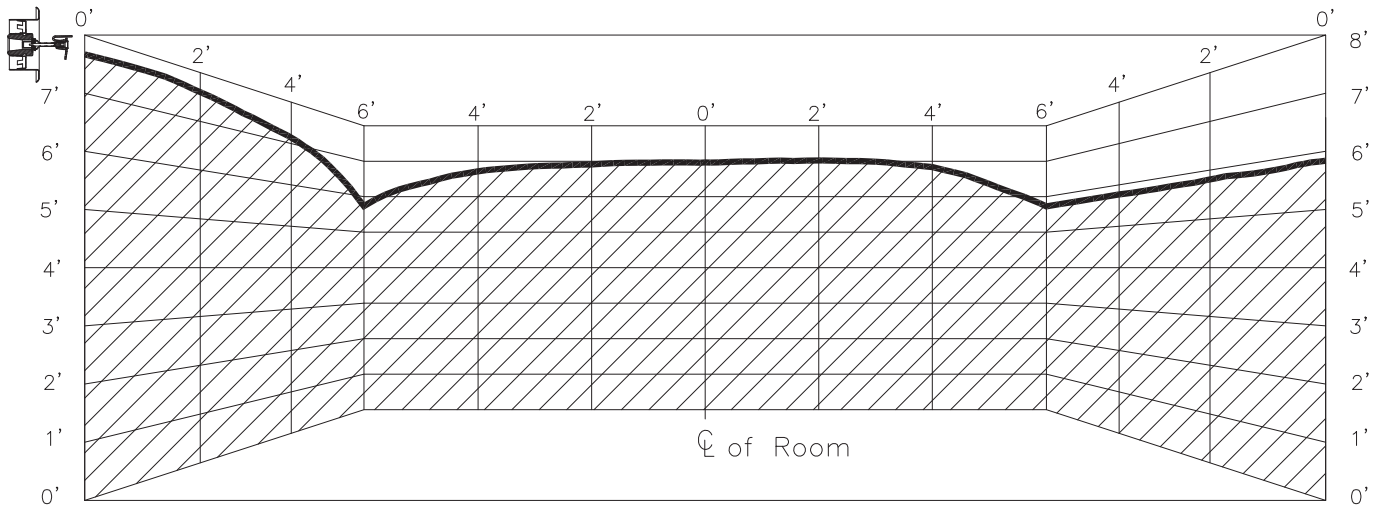

F1RES44_HSW-12x12-4

NOMINAL WETTING PATTERN
 12ft.x12ft. COVERAGE AREA (Or less)
 4"-6" DEFLECTOR TO CEILING DISTANCE

12 GPM

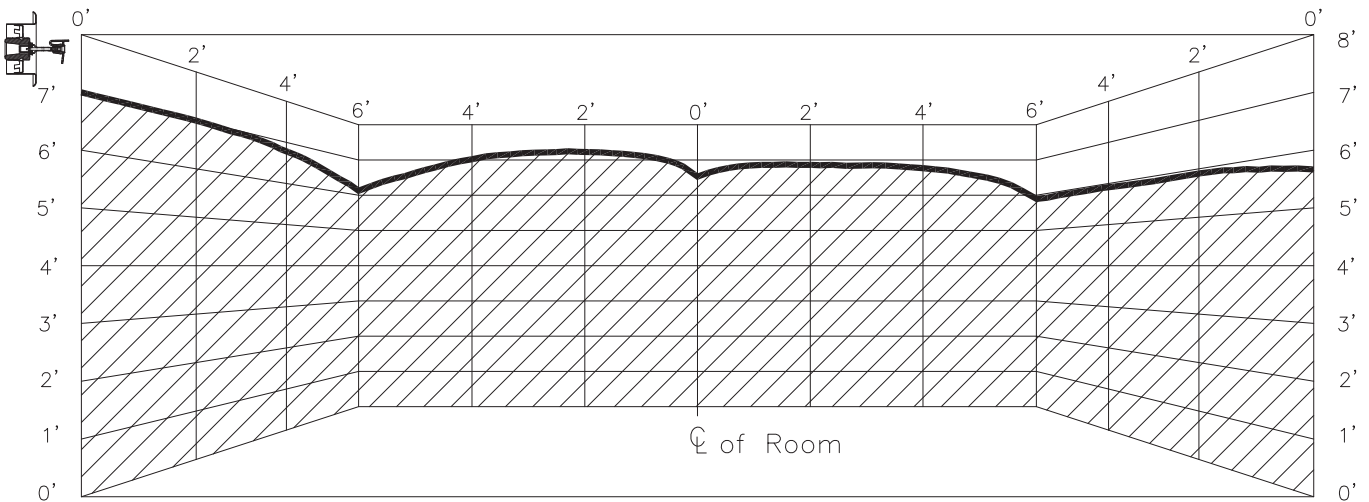

F1RES44_HSW-12x12-6

NOMINAL WETTING PATTERN
 12ft.x12ft. COVERAGE AREA (Or less)
 6"-12" DEFLECTOR TO CEILING DISTANCE

14 GPM

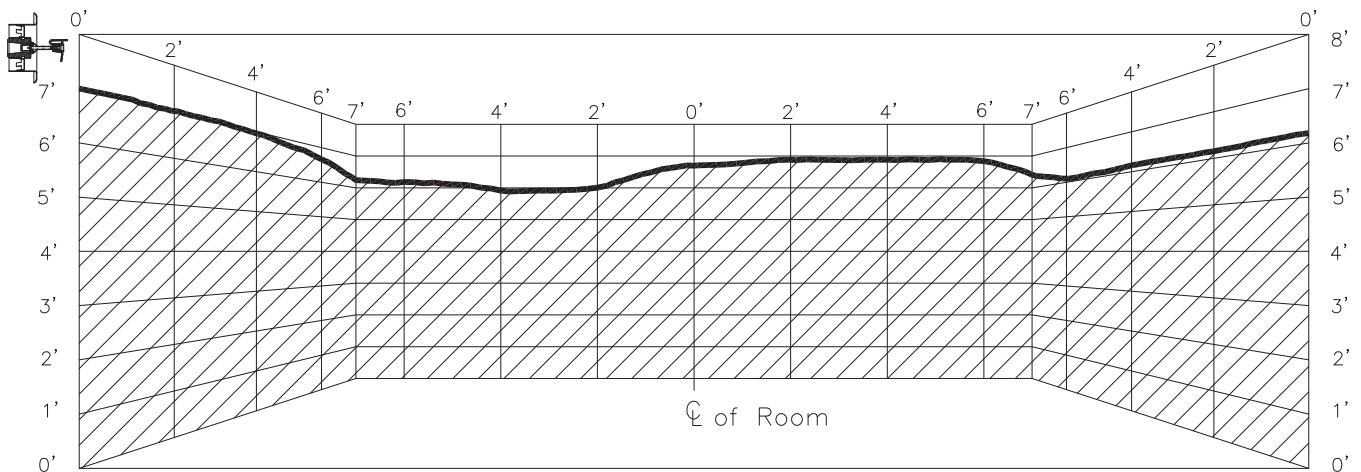

F1RES44_HSW-14x14-6

NOMINAL WETTING PATTERN
 14ft.x14ft. COVERAGE AREA
 6"-12" DEFLECTOR TO CEILING DISTANCE

16 GPM

F1 Res 44 HSW & F1 Res 44 Recessed HSW/F2 Wetting Patterns (cont.):

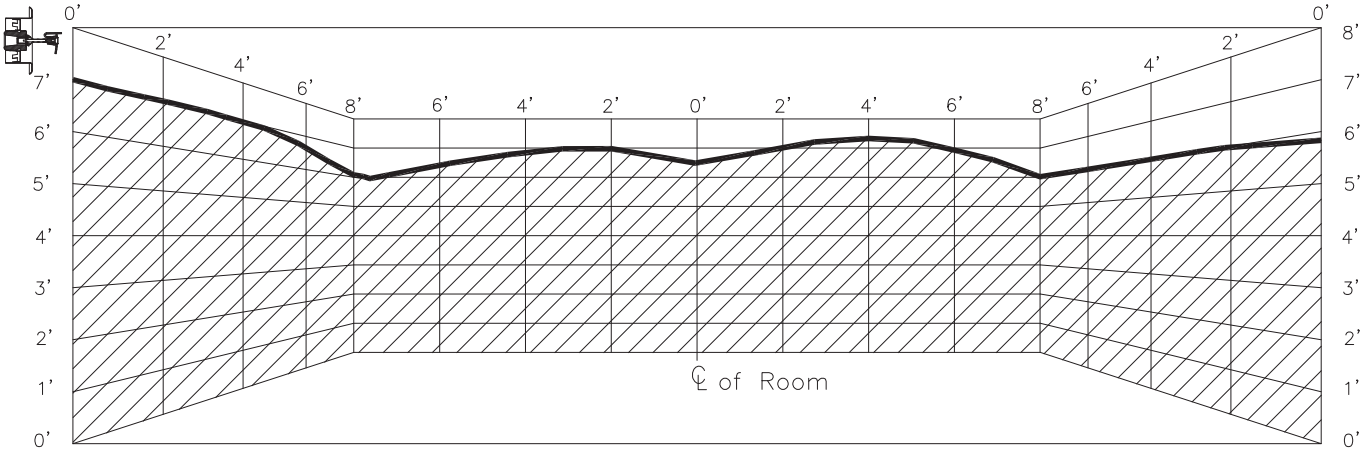

F1RES44_HSW-16x16-6

NOMINAL WETTING PATTERN
 16ft.x16ft. COVERAGE AREA
 6"-12" DEFLECTOR TO CEILING DISTANCE

17 GPM

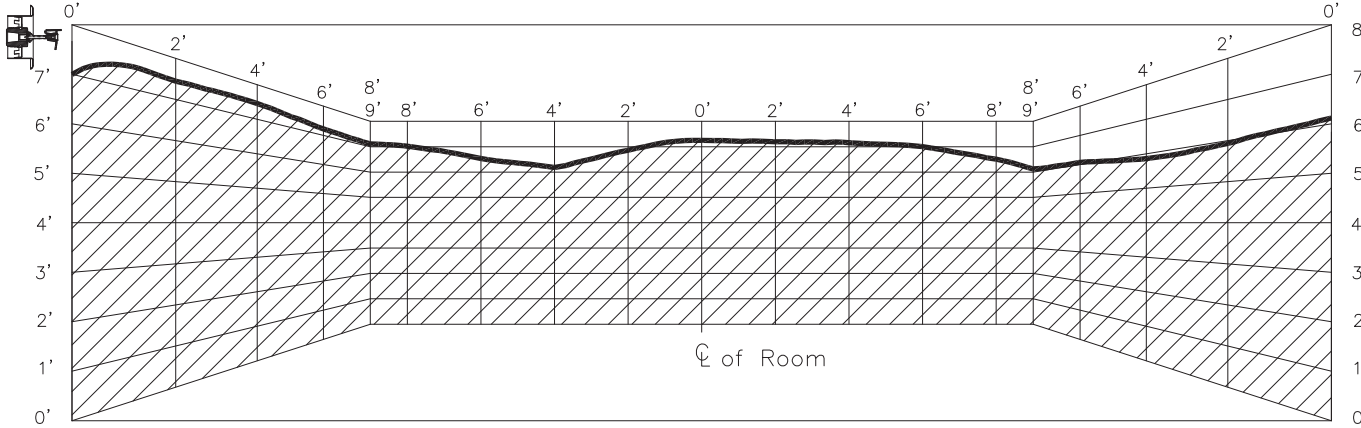

F1RES44_HSW-16x18-6

NOMINAL WETTING PATTERN
 16ft.x18ft. COVERAGE AREA
 6"-12" DEFLECTOR TO CEILING DISTANCE

20 GPM

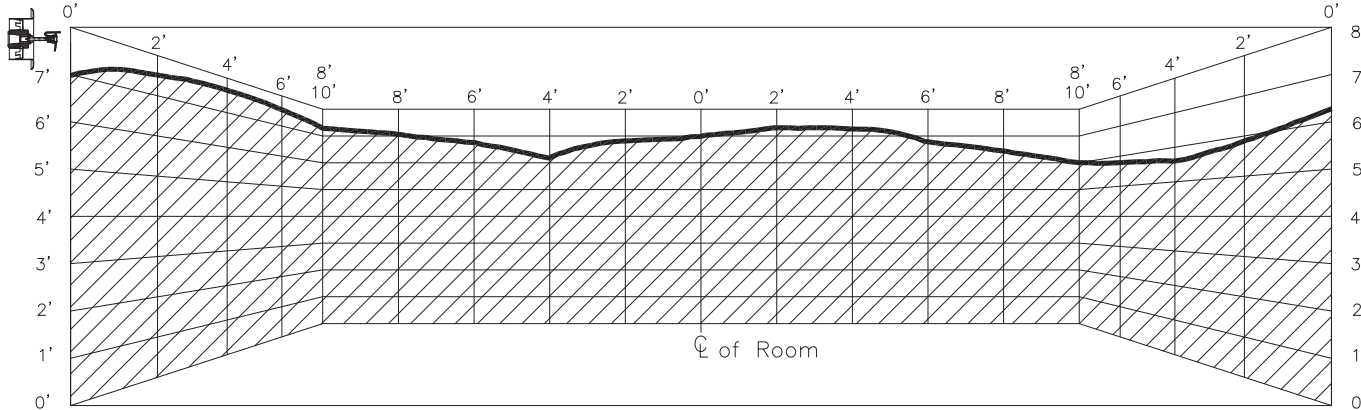

F1RES44_HSW-16x20-6

NOMINAL WETTING PATTERN
 16ft.x20ft. COVERAGE AREA
 6"-12" DEFLECTOR TO CEILING DISTANCE

23 GPM

F1 Res 58 HSW & Recessed HSW/F2:

F1 Res 58 HSW

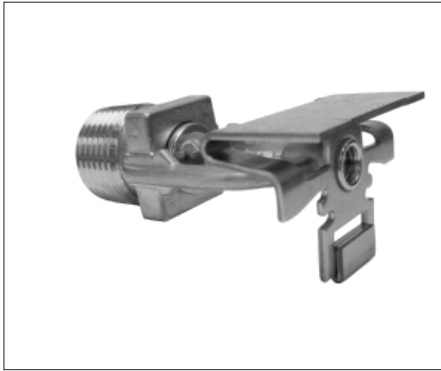

F1 Res 58 Recessed HSW/F2

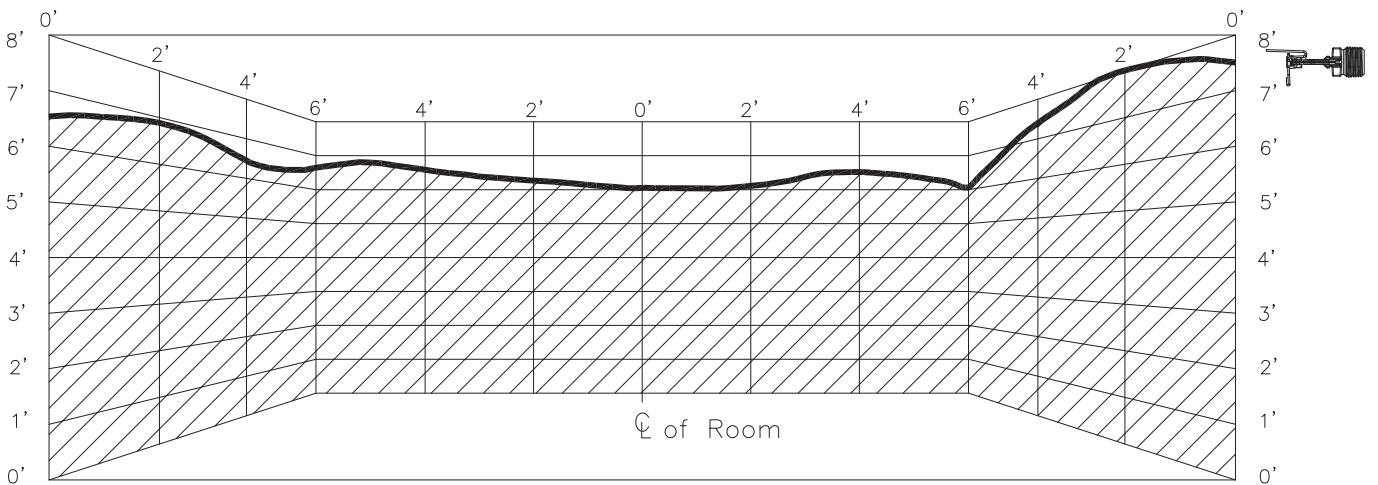
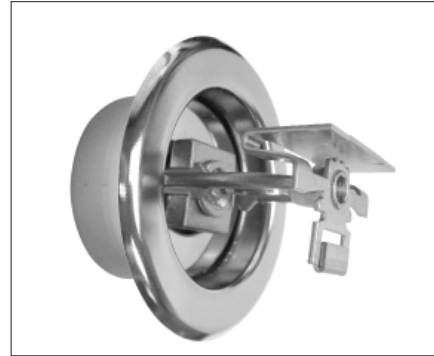

F1RES58_HSW-12x12-4

NOMINAL WETTING PATTERN
 12ft.x12ft. COVERAGE AREA (Or less)
 4"-16" DEFLECTOR TO CEILING DISTANCE

16 GPM

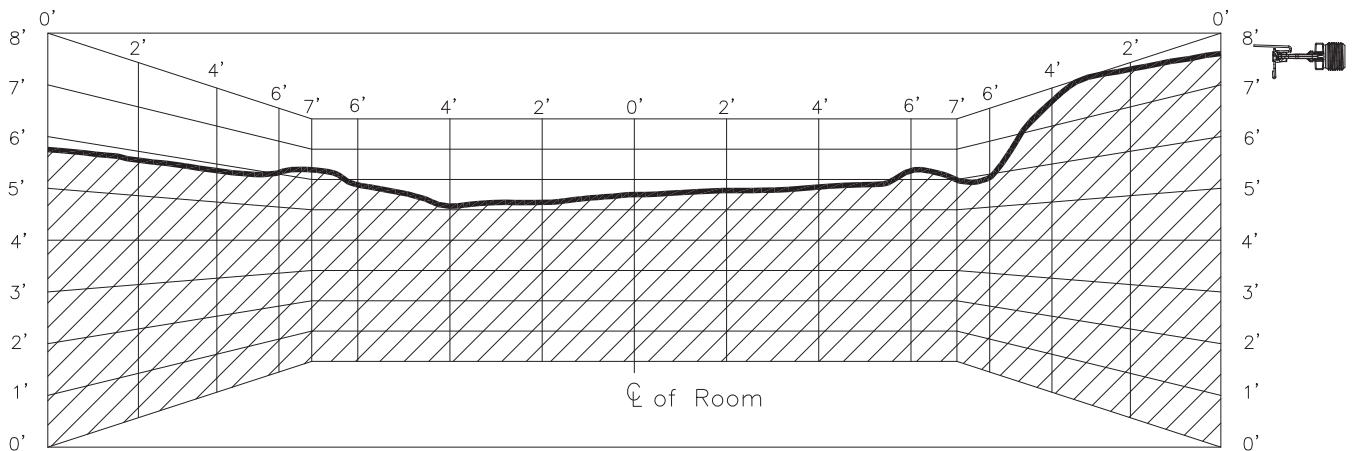

F1RES58_HSW-14x14-4

NOMINAL WETTING PATTERN
 14ft.x14ft. COVERAGE AREA
 4"-6" DEFLECTOR TO CEILING DISTANCE

18 GPM

F1 Res 58 HSW & Recessed HSW/F2 (cont.):

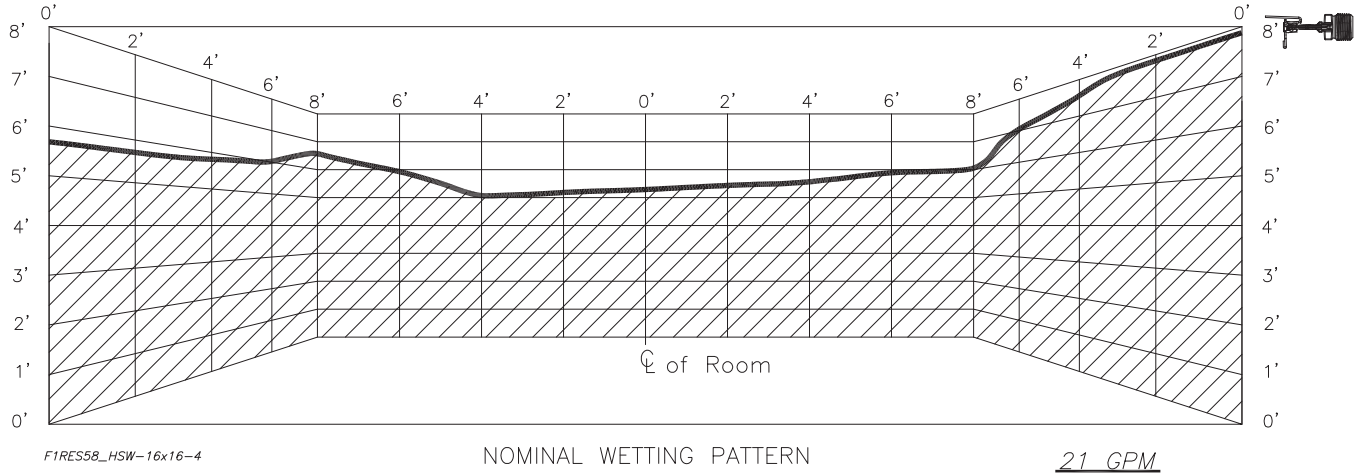

F1RES58_HSW-16x16-4

NOMINAL WETTING PATTERN
16ft.x16ft. COVERAGE AREA
4"-6" DEFLECTOR TO CEILING DISTANCE

21 GPM

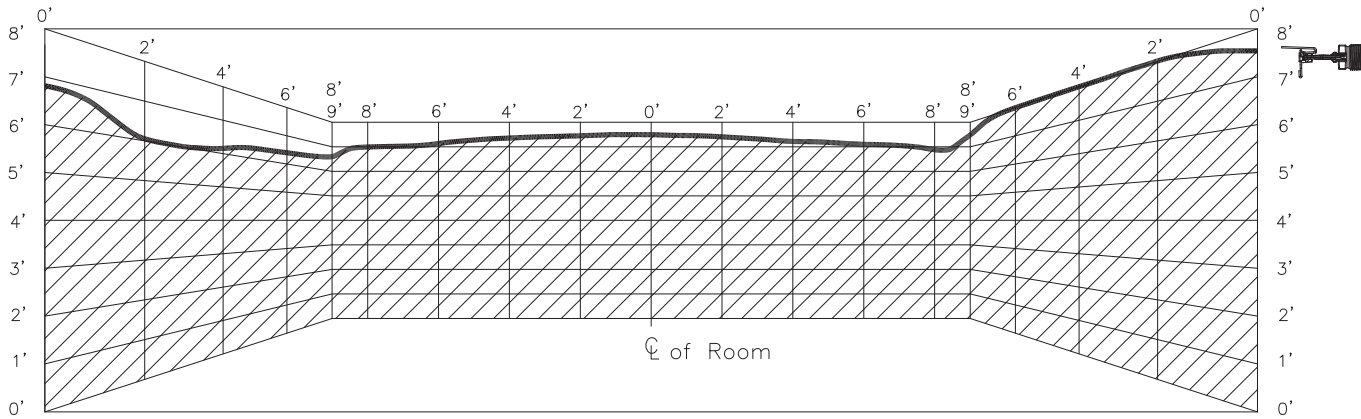

F1RES58_HSW-16x18-4

NOMINAL WETTING PATTERN
16ft.x18ft. COVERAGE AREA
4"-6" DEFLECTOR TO CEILING DISTANCE

25 GPM

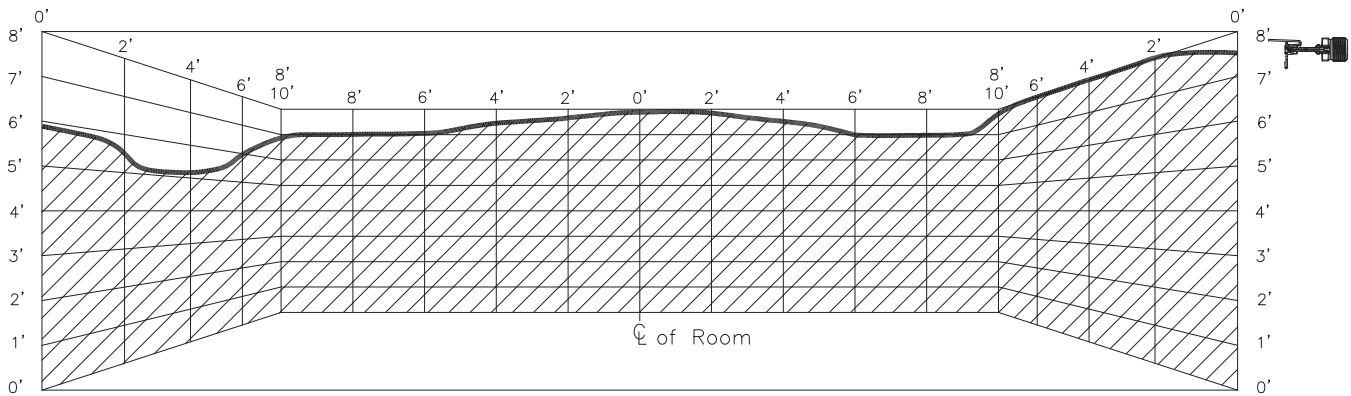

F1RES58_HSW-16x20-4

NOMINAL WETTING PATTERN
16ft.x20ft. COVERAGE AREA
4"-6" DEFLECTOR TO CEILING DISTANCE

29 GPM

F1 Res 58 HSW & Recessed HSW/F2 (cont.):

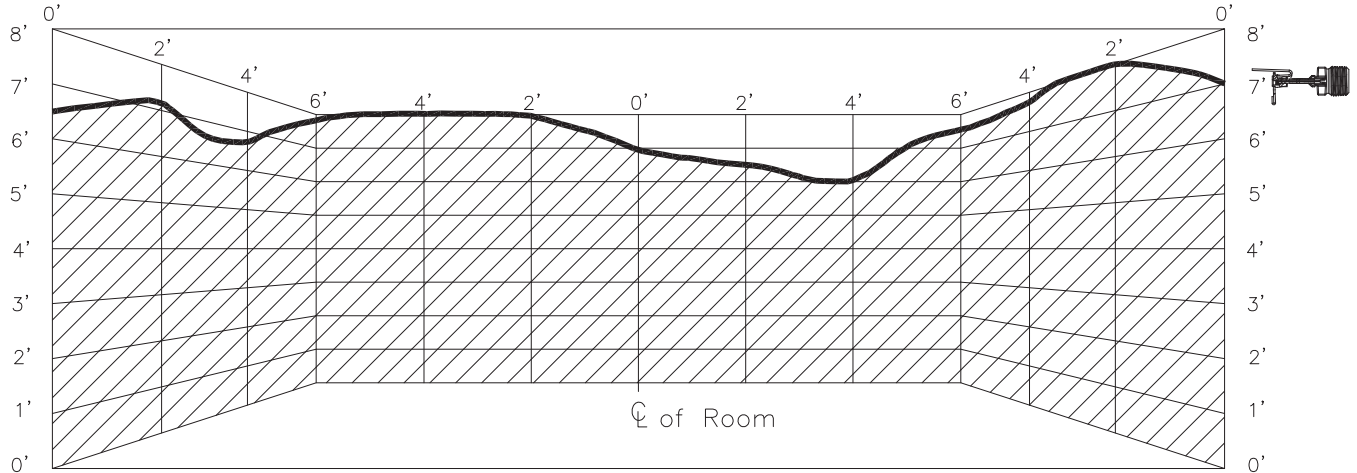

F1RES58_HSW-12x12-6

NOMINAL WETTING PATTERN
12ft.x12ft. COVERAGE AREA (Or less)
6"-12" DEFLECTOR TO CEILING DISTANCE

22 GPM

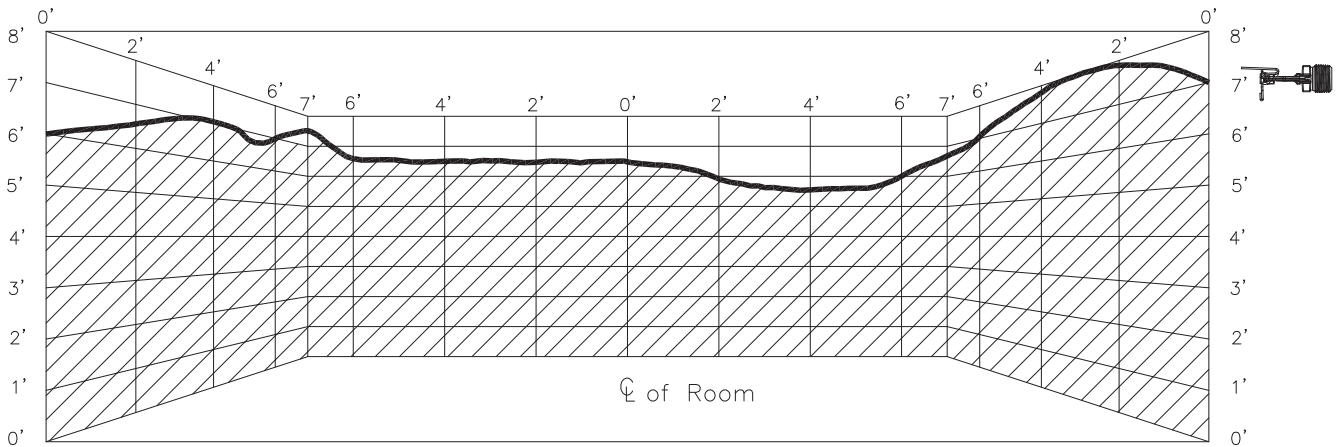

F1RES58_HSW-14x14-6

NOMINAL WETTING PATTERN
14ft.x14ft. COVERAGE AREA
6"-12" DEFLECTOR TO CEILING DISTANCE

22 GPM

F1 Res 58 HSW & Recessed HSW/F2 (cont.):

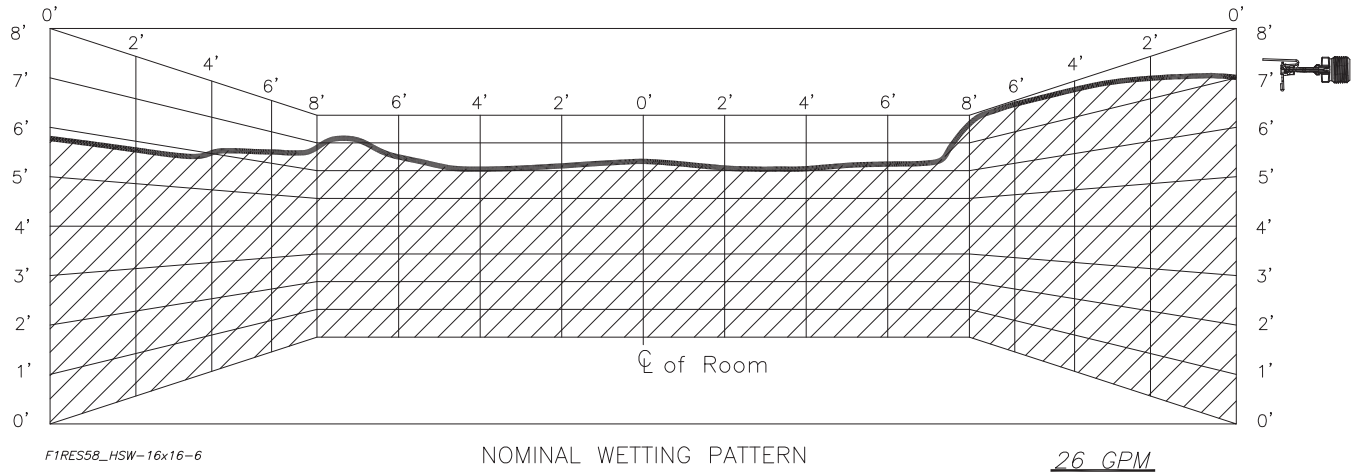

F1RES58_HSW-16x16-6

NOMINAL WETTING PATTERN
 16ft.x16ft. COVERAGE AREA
 6"-12" DEFLECTOR TO CEILING DISTANCE

26 GPM

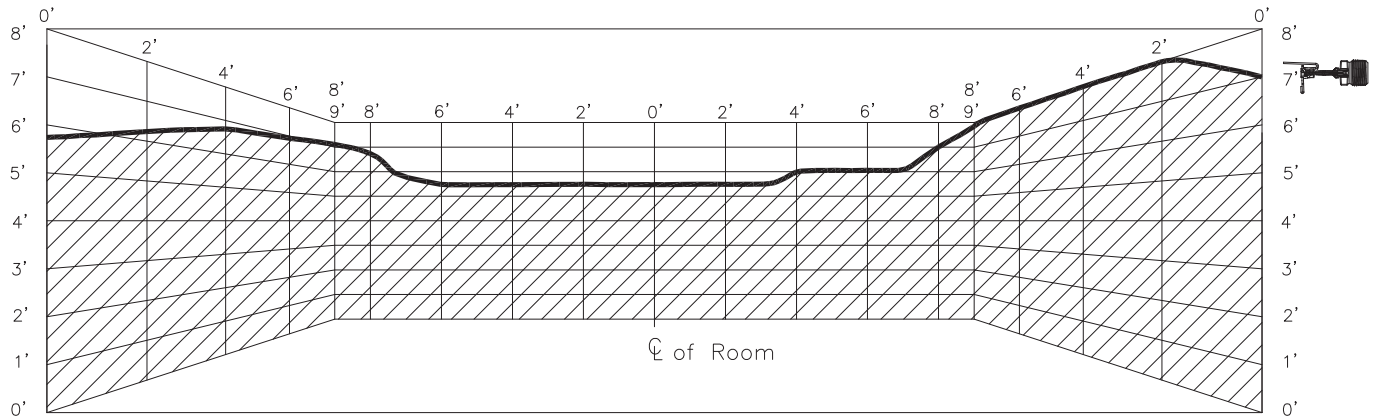

F1RES58_HSW-16x18-6

NOMINAL WETTING PATTERN
 16ft.x18ft. COVERAGE AREA
 6"-12" DEFLECTOR TO CEILING DISTANCE

31 GPM

F1 Res 58 HSWX & Recessed HSWX/F2:

**F1 Res 58 HSWX
Recessed HSWX/F2**

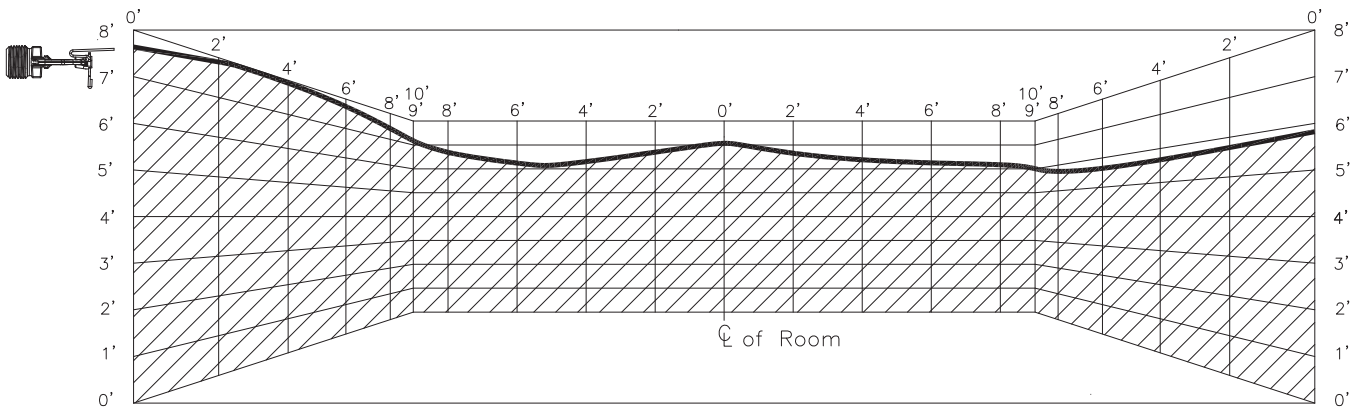

F1RES58HSWX_18_29

NOMINAL WETTING PATTERN
18ft.x20ft. COVERAGE AREA
4"-6" DEFLECTOR TO CEILING DISTANCE

29 GPM

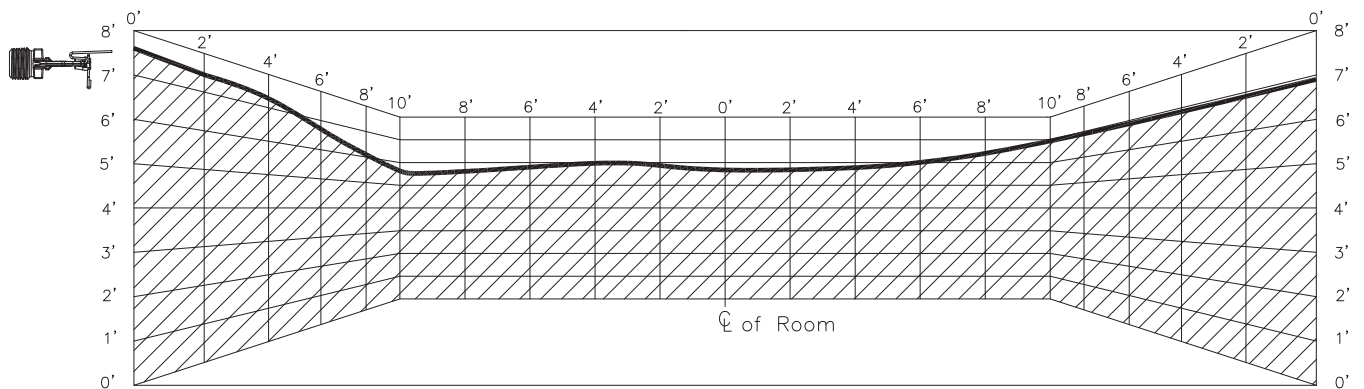

F1RES58HSWX_20

NOMINAL WETTING PATTERN
20ft.x20ft. COVERAGE AREA
4"-6" DEFLECTOR TO CEILING DISTANCE

30 GPM

F1 Res 58 HSWX & Recessed HSWX/F2 (cont.):

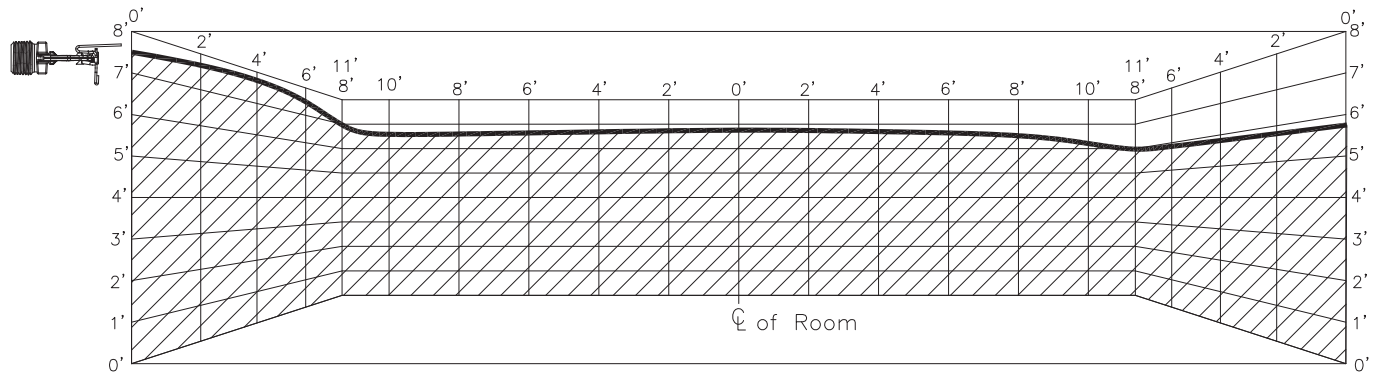

F1RES58HSWX_16x22_33

NOMINAL WETTING PATTERN
16ft.x22ft. COVERAGE AREA
4"-6" DEFLECTOR TO CEILING DISTANCE

33 GPM

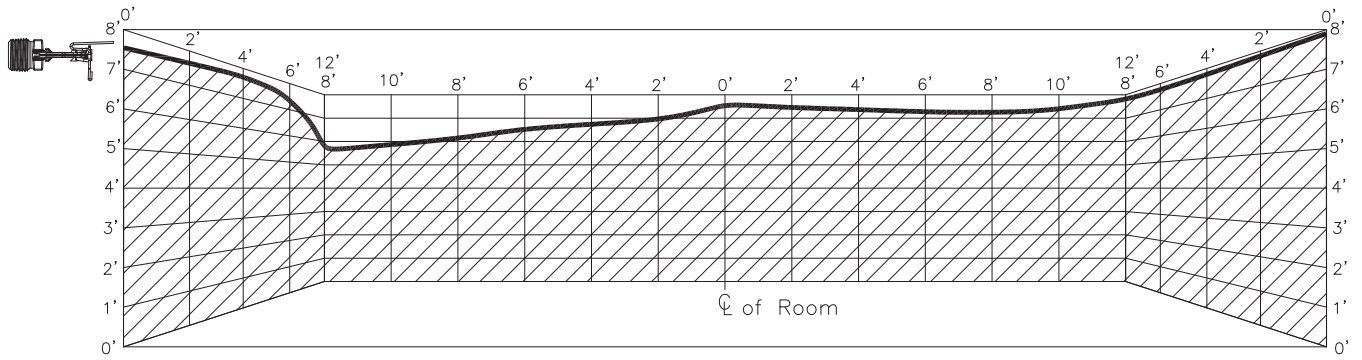

F1RES58HSWX_16x24_38

NOMINAL WETTING PATTERN
16ft.x24ft. COVERAGE AREA
4"-6" DEFLECTOR TO CEILING DISTANCE

38 GPM

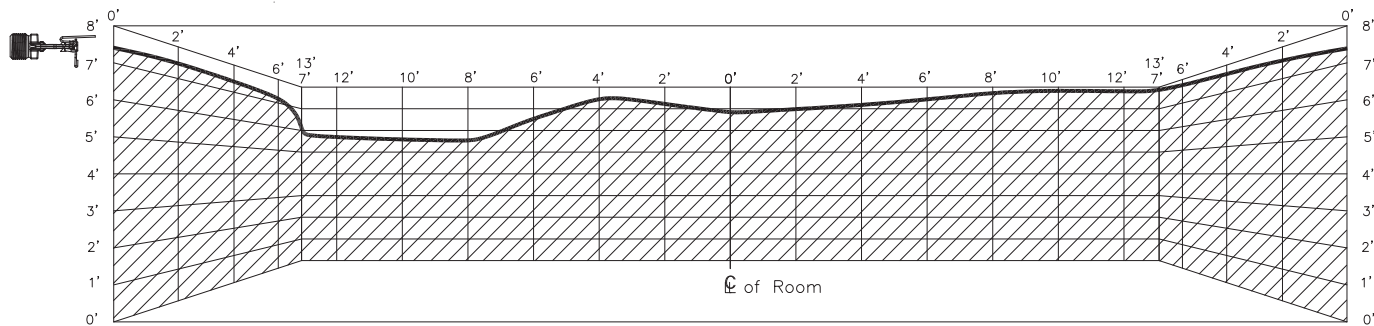

F1RES58HSWX_14x26_42

NOMINAL WETTING PATTERN
14ft.x26ft. COVERAGE AREA
4"-6" DEFLECTOR TO CEILING DISTANCE

42 GPM

F1 Res 58 HSWX & Recessed HSWX/F2 (cont.):

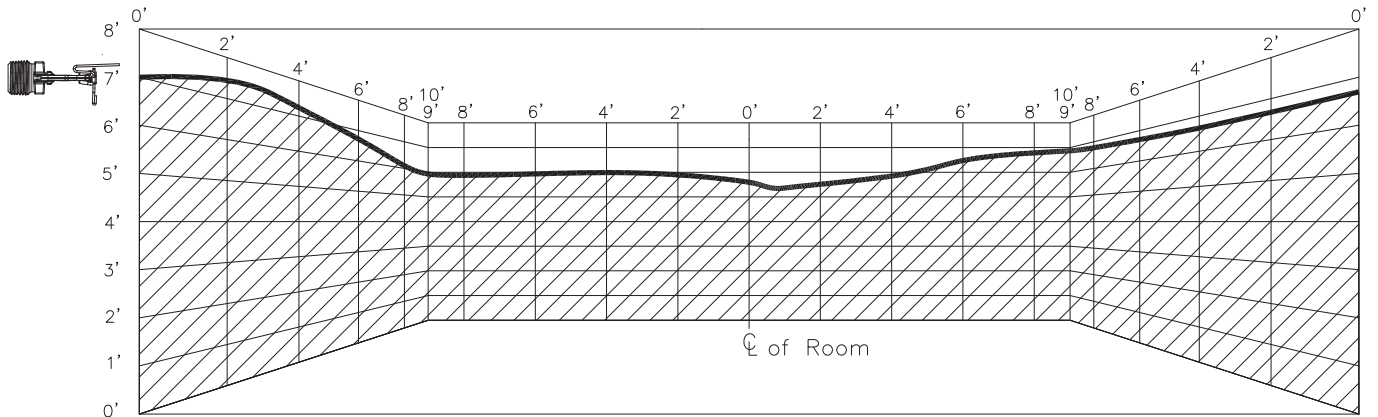

F1RES58HSWX_18_35

NOMINAL WETTING PATTERN
18ft.x20ft. COVERAGE AREA
6"-12" DEFLECTOR TO CEILING DISTANCE

35 GPM

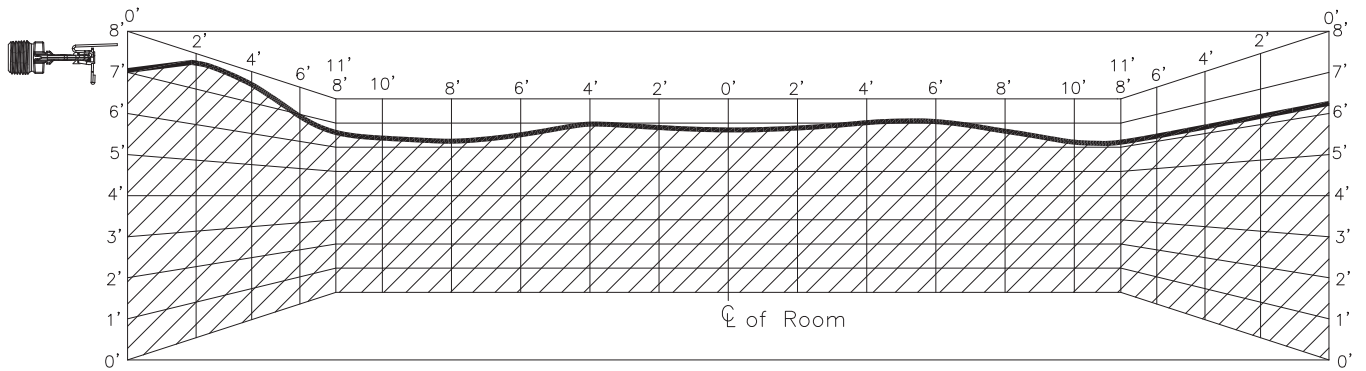

F1RES58HSWX_16x22_38

NOMINAL WETTING PATTERN
16ft.x22ft. COVERAGE AREA
6"-12" DEFLECTOR TO CEILING DISTANCE

38 GPM

F1 Res 58 HSWX & Recessed HSWX/F2 (cont.):

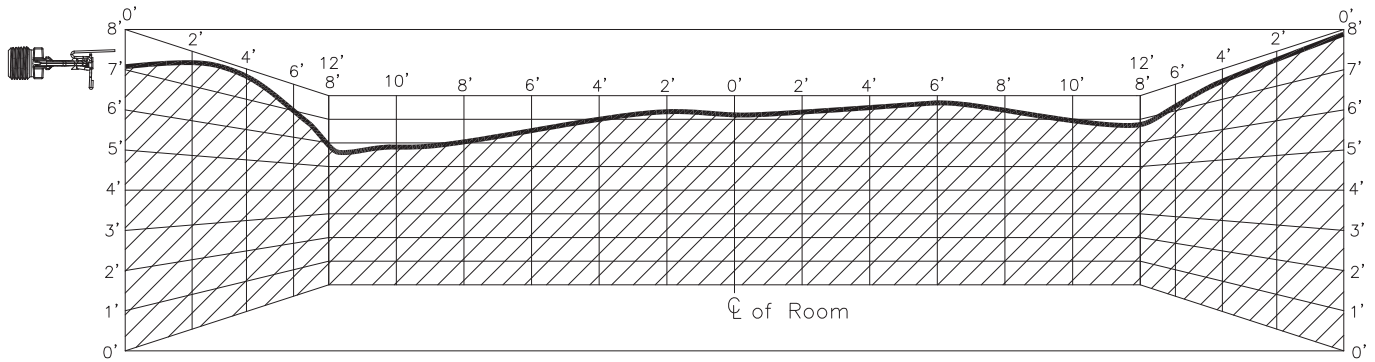

F1RES58HSWX_16x24_42

NOMINAL WETTING PATTERN
16ft.x24ft. COVERAGE AREA
6"-12" DEFLECTOR TO CEILING DISTANCE

42 GPM

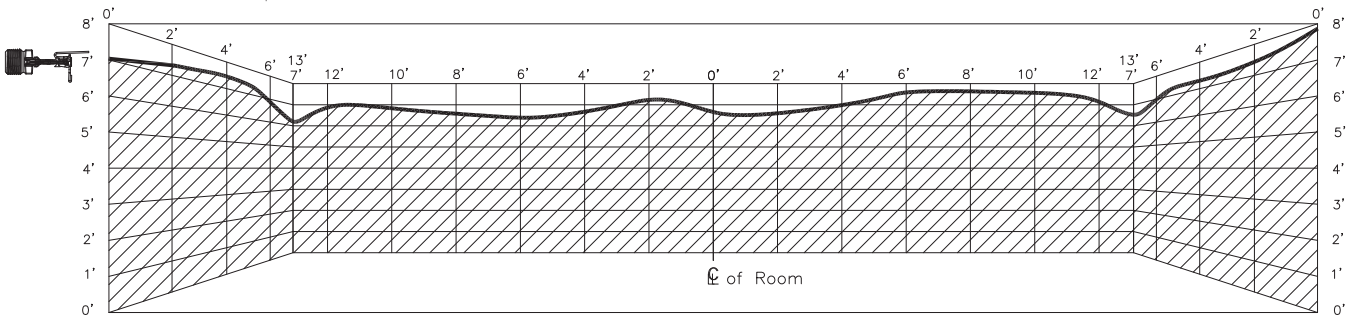

F1RES58HSWX_14x26_46

NOMINAL WETTING PATTERN
14ft.x26ft. COVERAGE AREA
6"-12" DEFLECTOR TO CEILING DISTANCE

46 GPM

RFC 30 Flat Concealed Pendant:

RFC 30 Flat Concealed Pendant

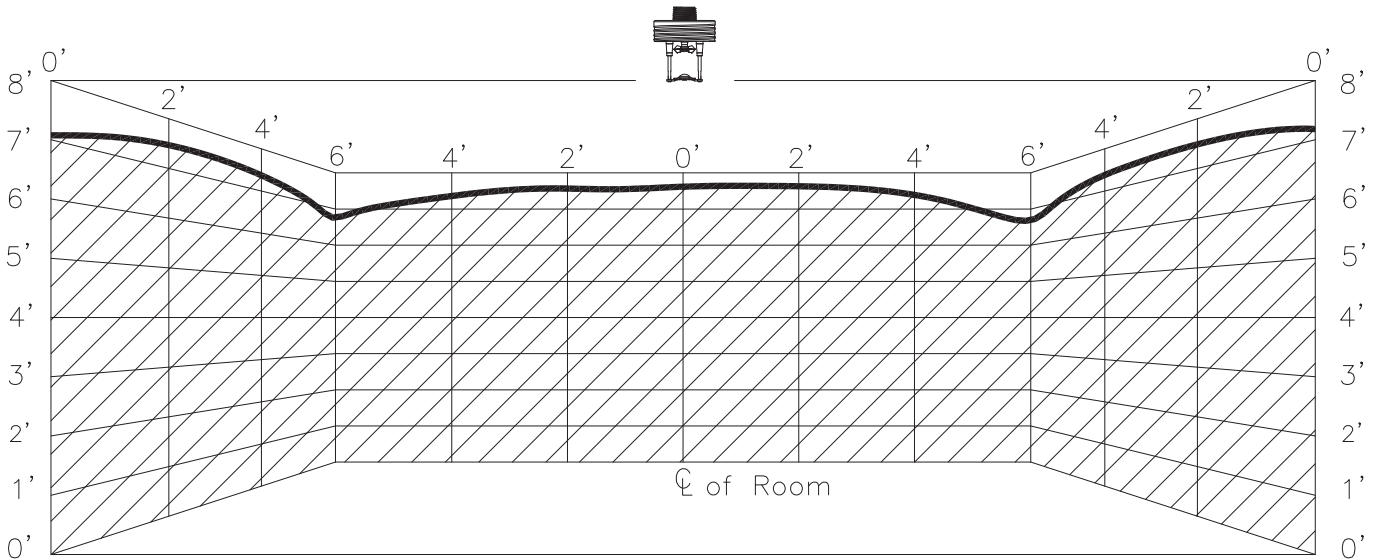

RFC30 FC PEND-12

RFC30 FLAT CONCEALED PENDENT
12x12 COVERAGE AREA

8 GPM

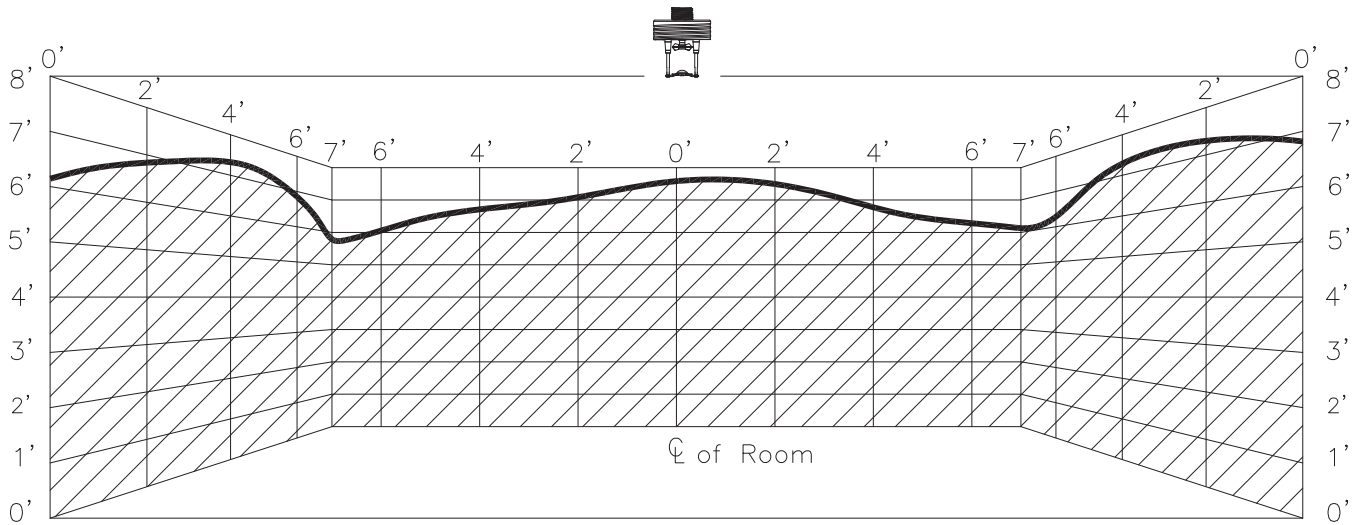

RFC30 FC PEND-14

RFC30 FLAT CONCEALED PENDENT
14x14 COVERAGE AREA

9 GPM

RFC 43 Flat Concealed Pendent Wetting Patterns:

RFC 43 Flat Concealed Pendent

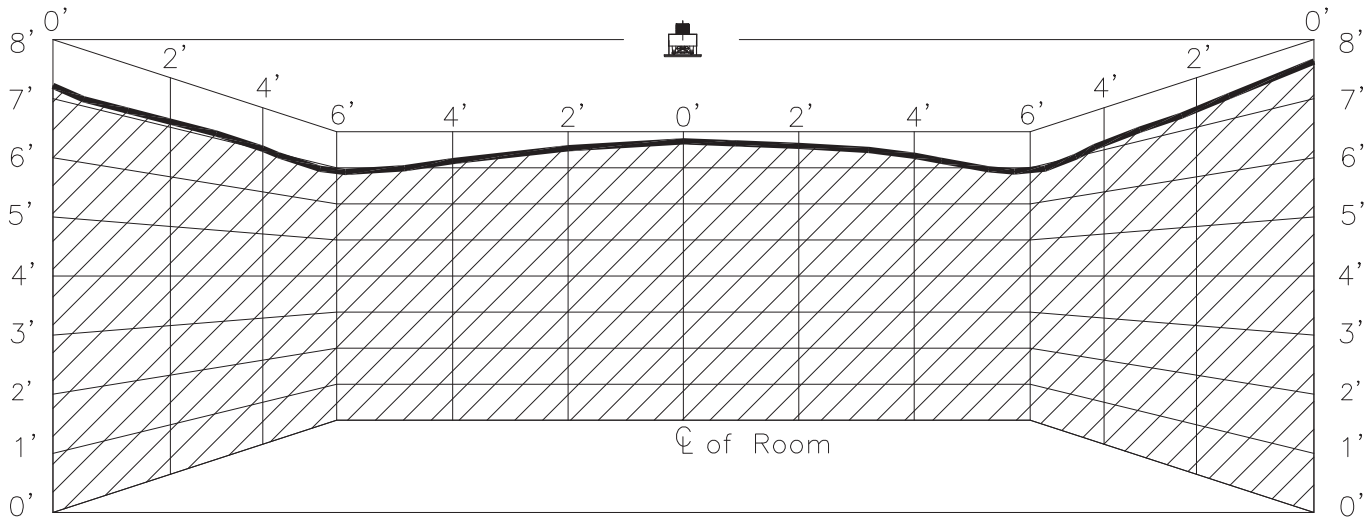

FILE NAME
RFC43-12

NOMINAL WETTING PATTERN
12x12 COVERAGE AREA (Or less)

12 GPM

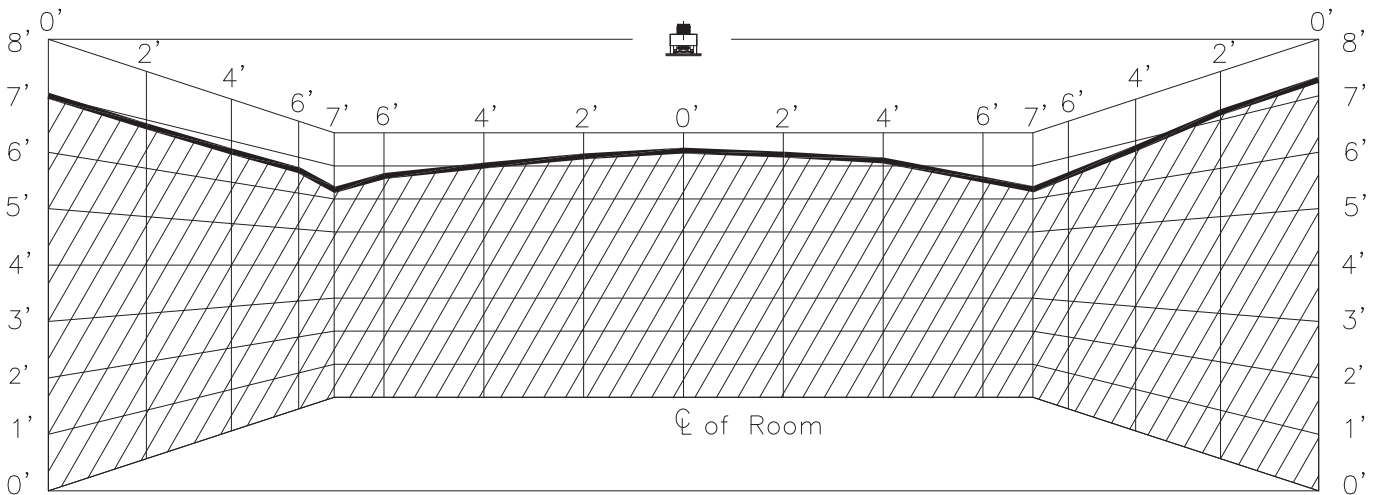

FILE NAME
RFC43-14

NOMINAL WETTING PATTERN
14x14 COVERAGE AREA

13 GPM

RFC 43 Flat Concealed Pendent Wetting Patterns (cont.):

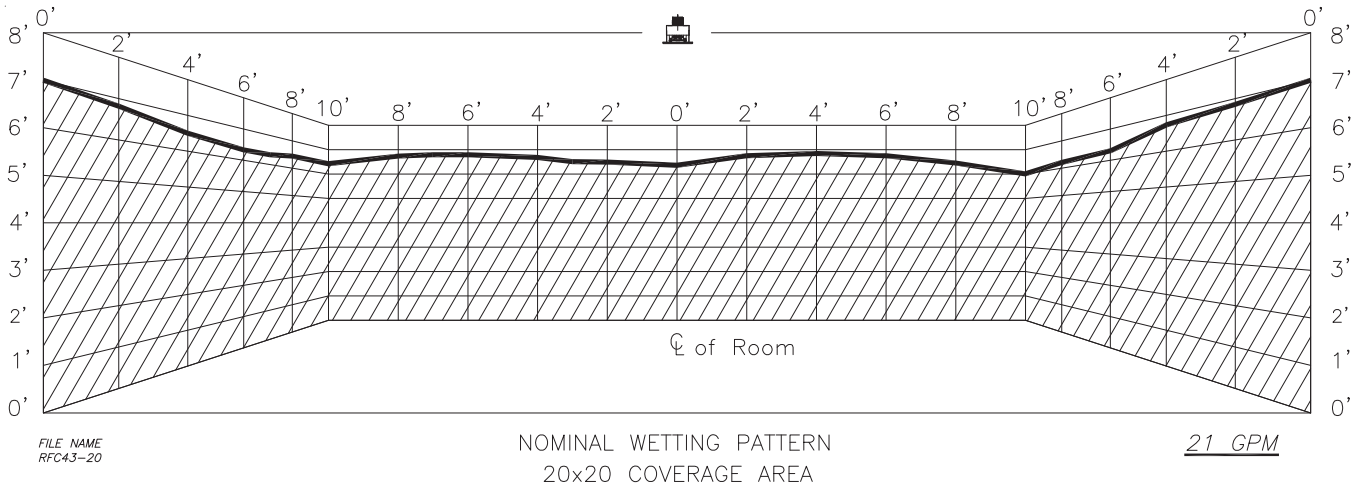
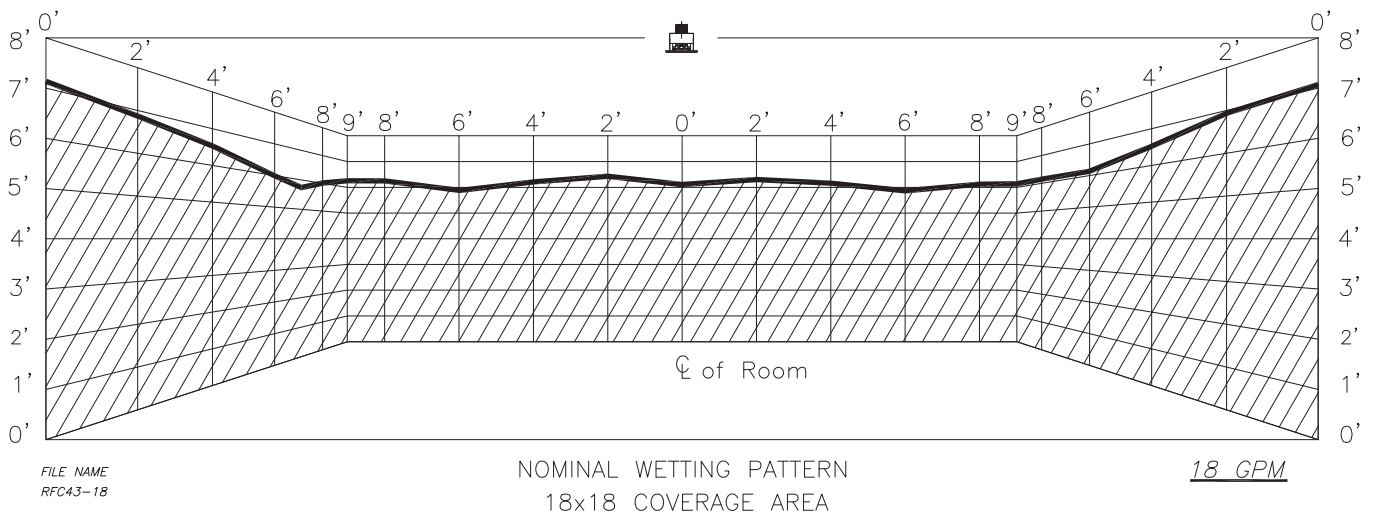
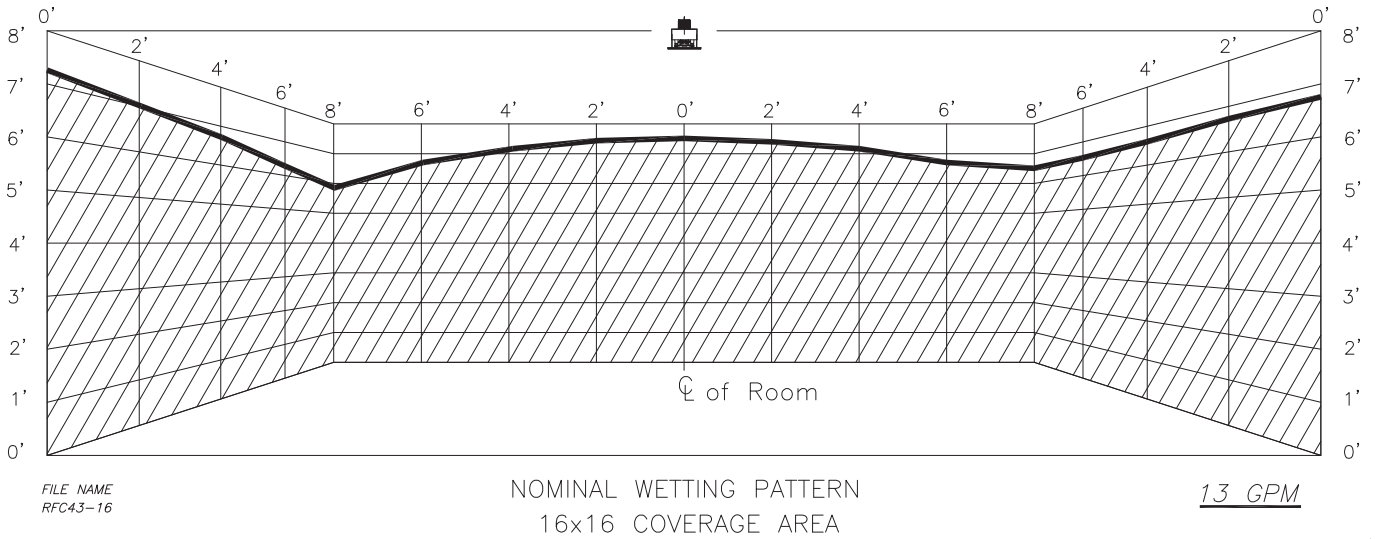

RFC 49 Flat Concealed Pendent Wetting Patterns:

RFC 49 Flat Concealed Pendent

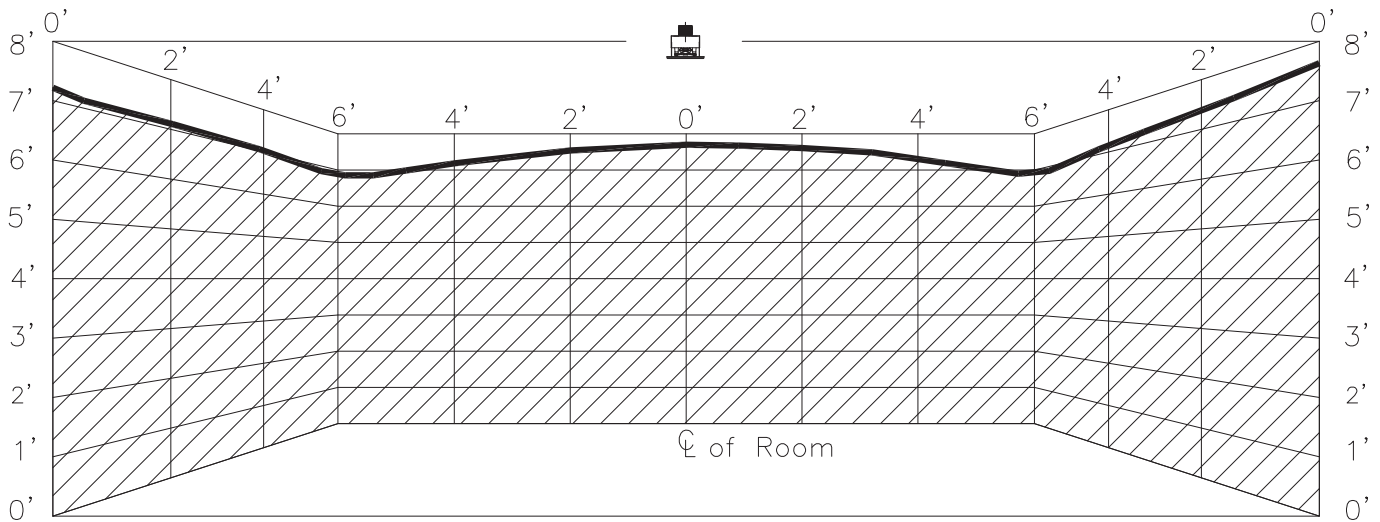

FILE NAME
RFC49-12

NOMINAL WETTING PATTERN
12x12 COVERAGE AREA (Or less)

13 GPM

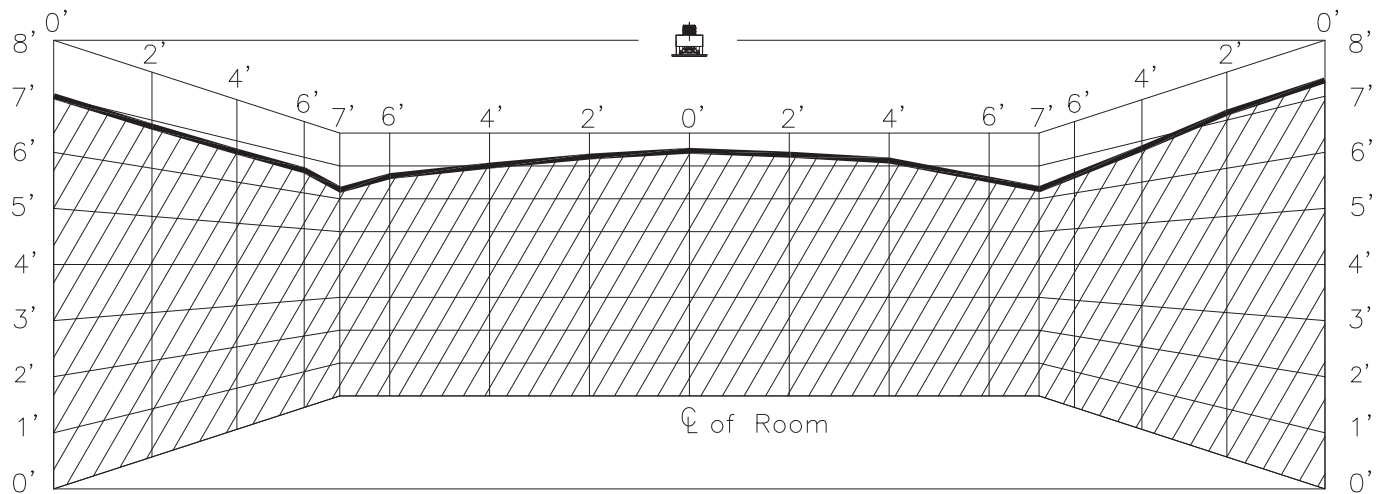

FILE NAME
RFC49-14

NOMINAL WETTING PATTERN
14x14 COVERAGE AREA

13 GPM

RFC 49 Flat Concealed Pendent Wetting Patterns (cont.):

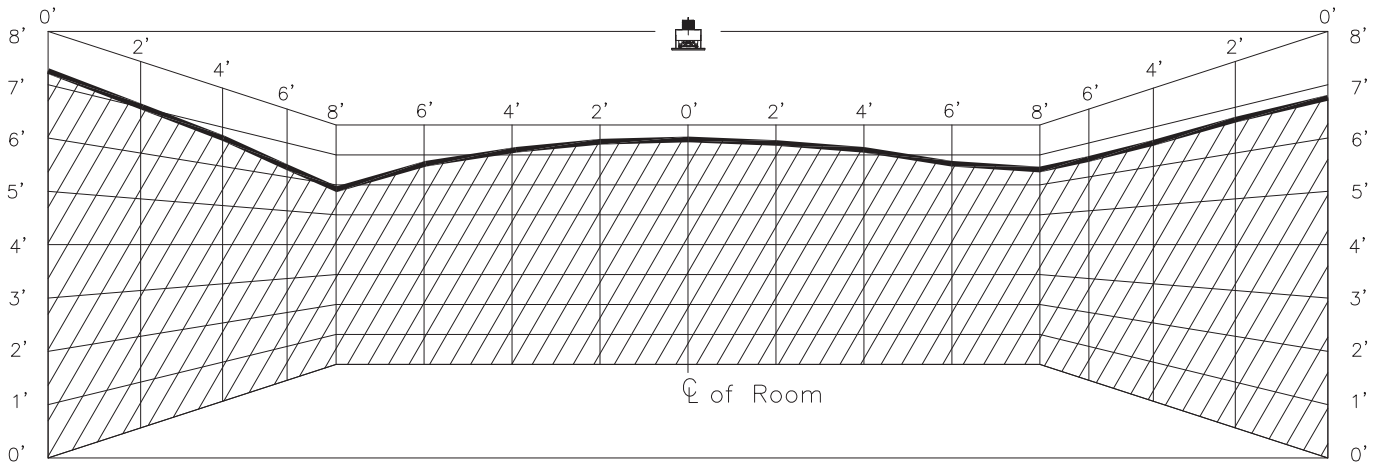

FILE NAME
RFC49-16

NOMINAL WETTING PATTERN
16x16 COVERAGE AREA

13 GPM

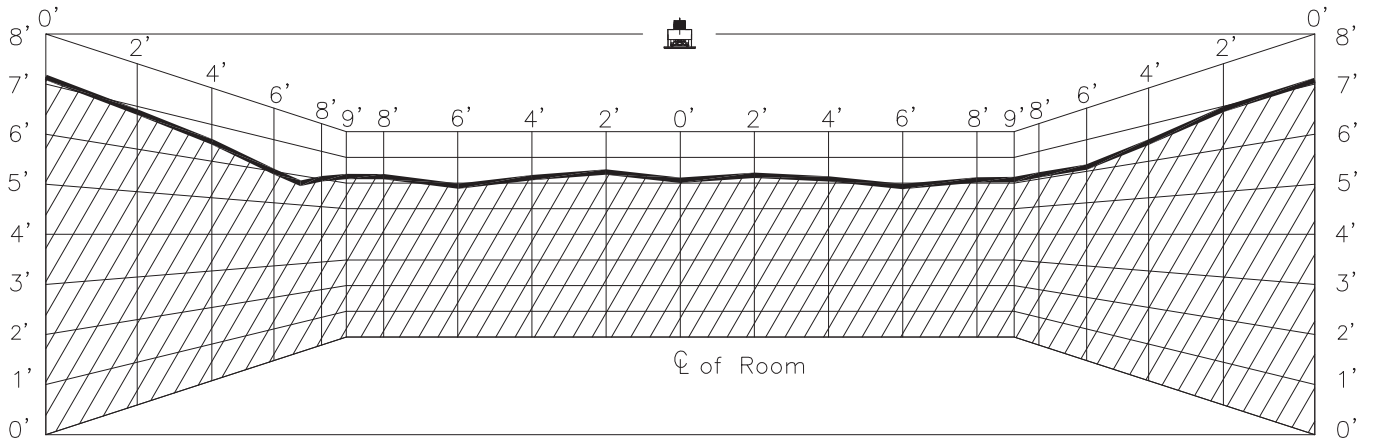

FILE NAME
RFC49-18

NOMINAL WETTING PATTERN
18x18 COVERAGE AREA

17 GPM

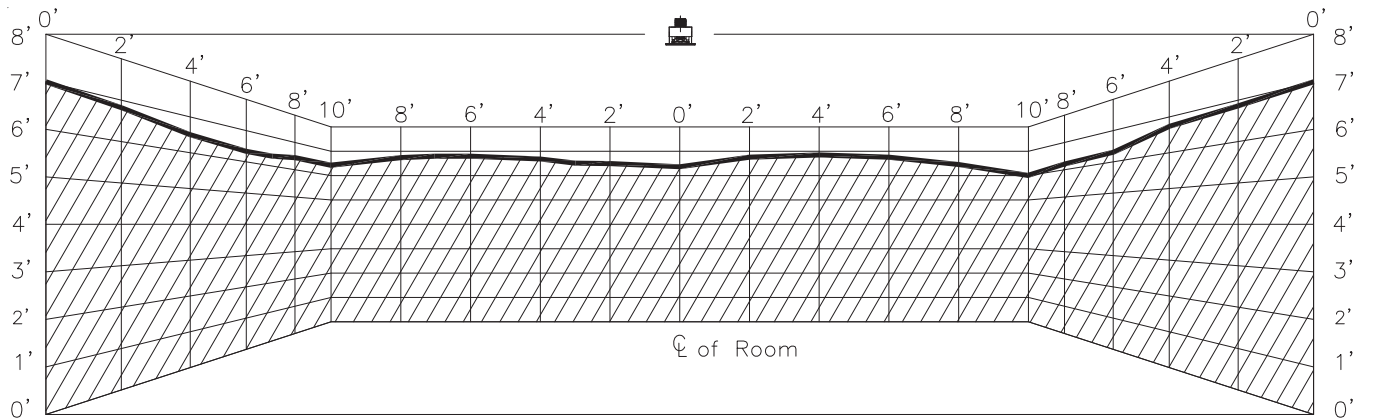

FILE NAME
RFC49-20

NOMINAL WETTING PATTERN
20x20 COVERAGE AREA

20 GPM

RFC 56 Flat Concealed Pendant:

RFC 56 Flat Concealed
Pendant

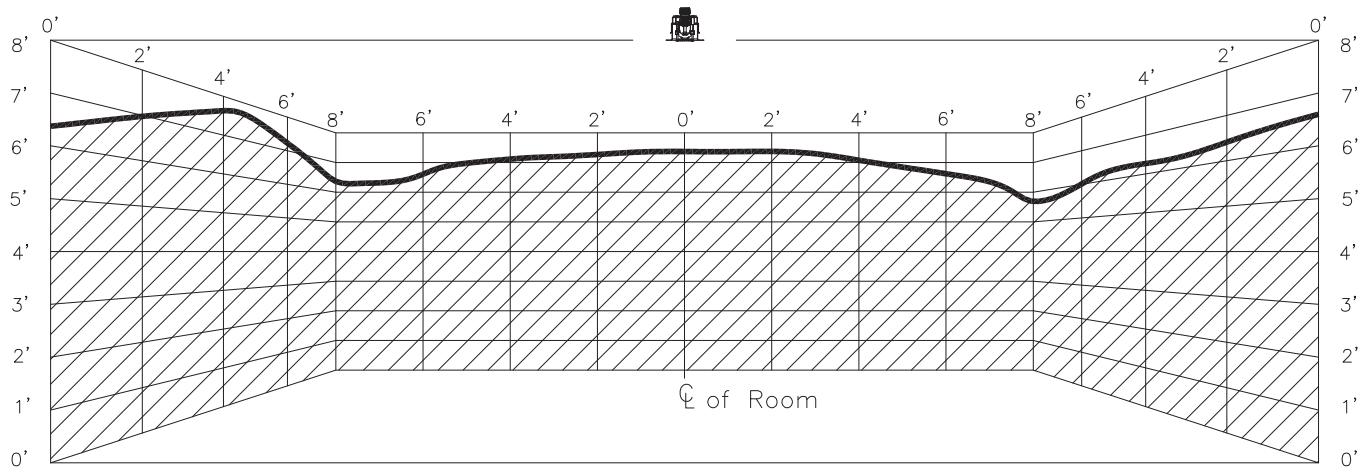

RFC56 PEND-16

RFC56 PENDENT
16X16 COVERAGE AREA

26 GPM

RFS 42 Flat HSW:

RFS 42 Flat HSW

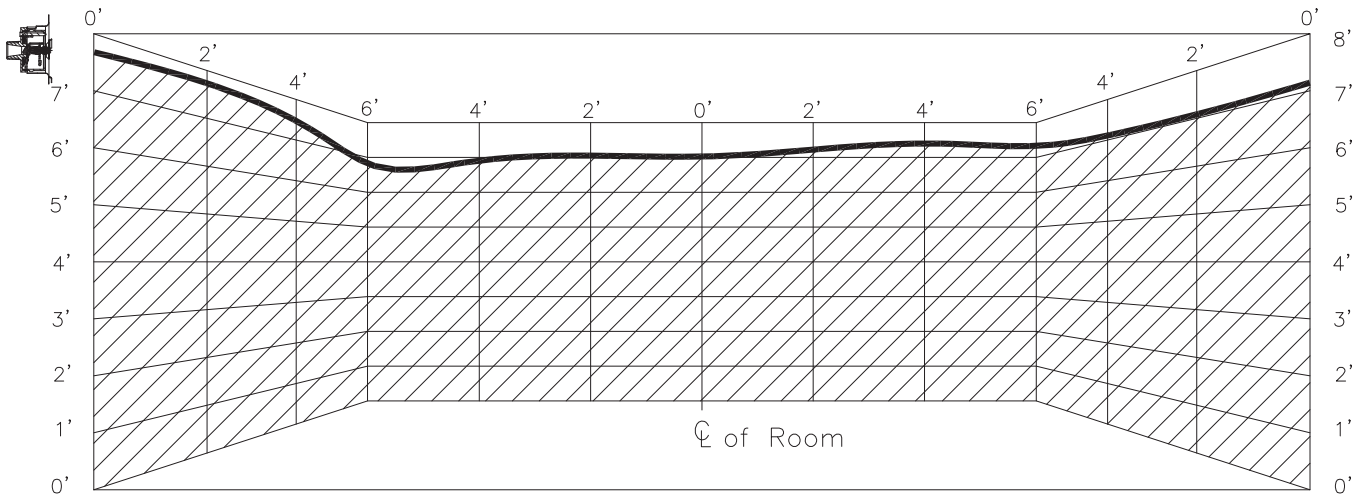

RFS42_HSW-12x12-4

NOMINAL WETTING PATTERN
 12ft.x12ft. COVERAGE AREA (Or less)
 4"-6" DEFLECTOR TO CEILING DISTANCE

12 GPM

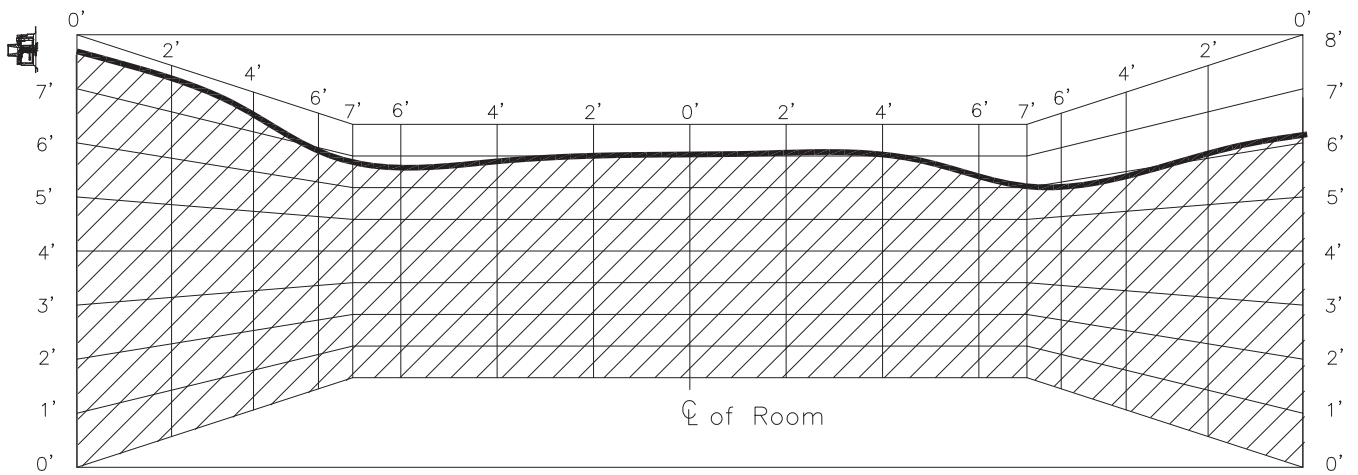

RFS42_HSW-14x14-4

NOMINAL WETTING PATTERN
 14ft.x14ft. COVERAGE AREA
 4"-6" DEFLECTOR TO CEILING DISTANCE

12 GPM

RFS 42 Flat HSW (cont.):

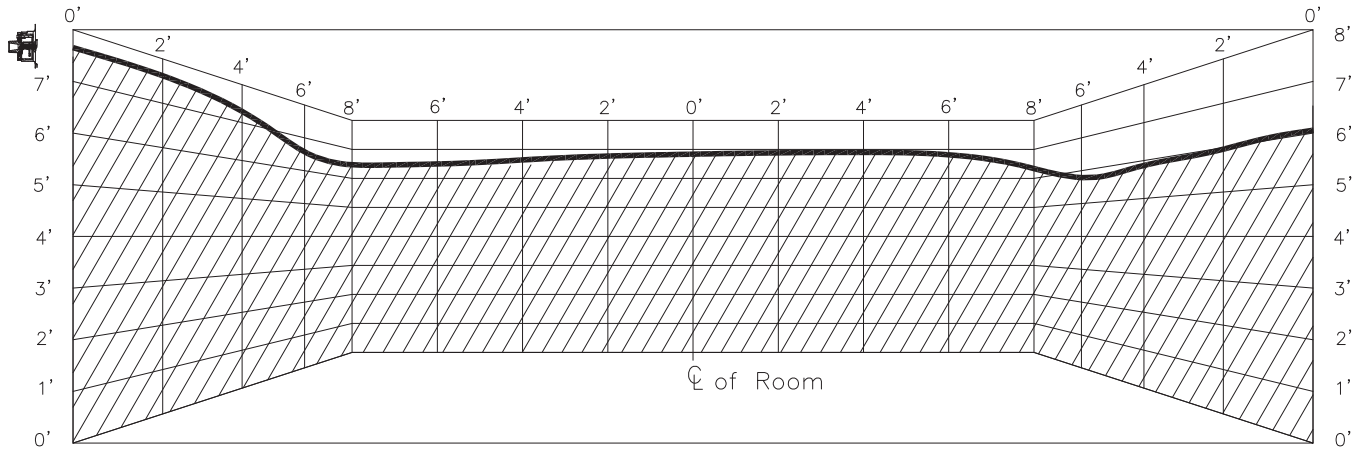

RFS42_HSW-16x16-4

NOMINAL WETTING PATTERN
16ft.x16ft. COVERAGE AREA
4" DEFLECTOR TO CEILING DISTANCE

16 GPM

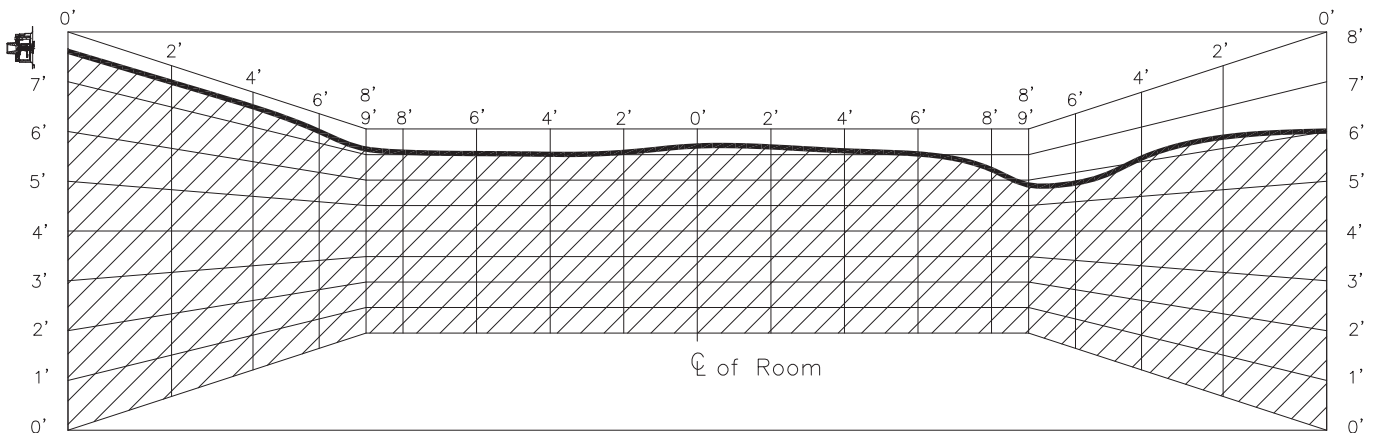

RFS42_HSW-16x18-4

NOMINAL WETTING PATTERN
16ft.x18ft. COVERAGE AREA
4" DEFLECTOR TO CEILING DISTANCE

18 GPM

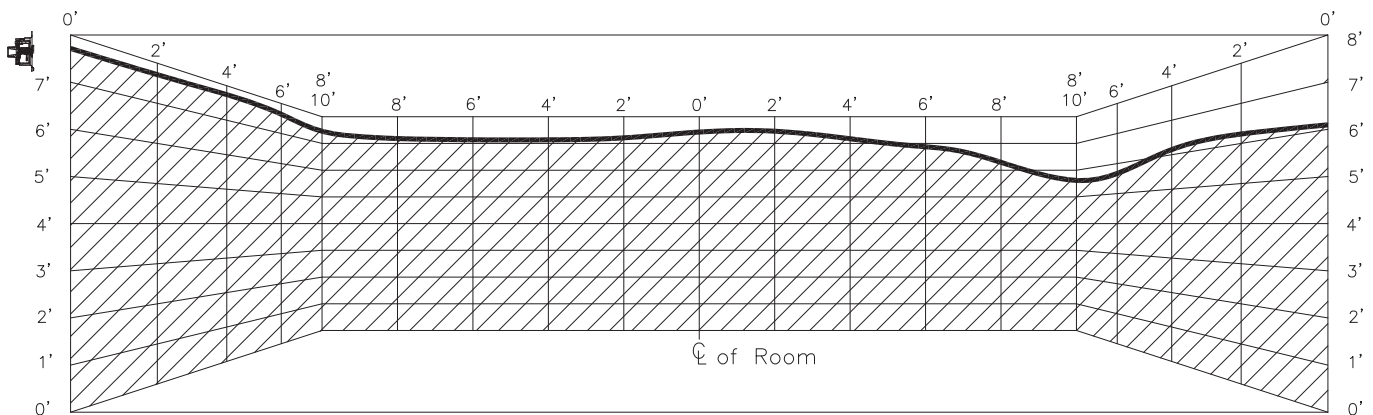

RFS42_HSW-16x20-4

NOMINAL WETTING PATTERN
16ft.x20ft. COVERAGE AREA
4"-6" DEFLECTOR TO CEILING DISTANCE

22 GPM

RFS 42 Flat HSW (cont.):

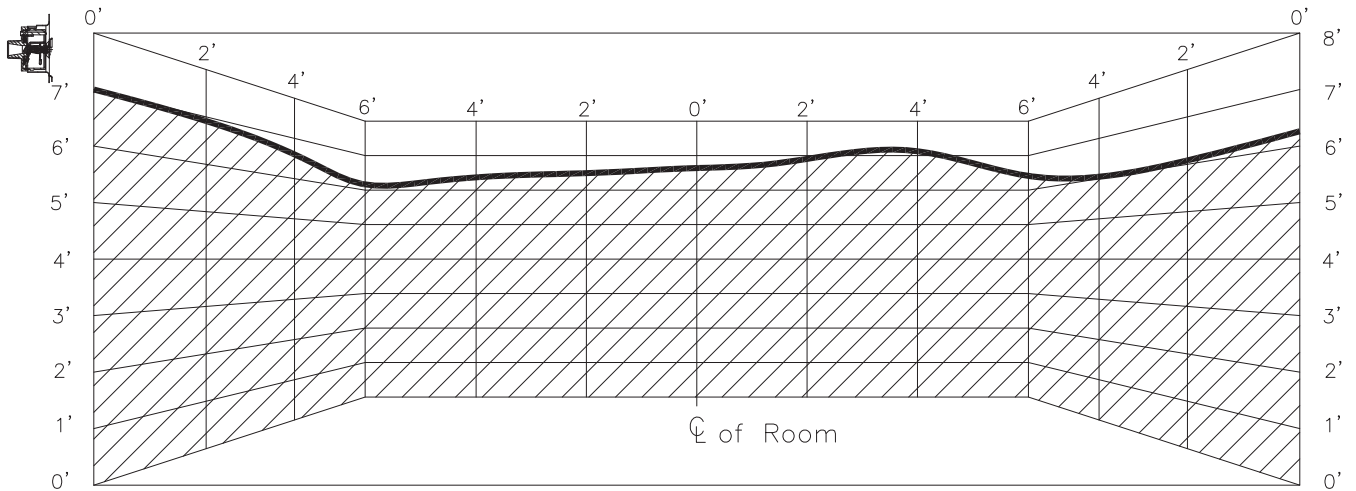

RFS42_HSW-12x12-12

NOMINAL WETTING PATTERN
 12ft.x12ft. COVERAGE AREA (Or less)
 6"-12" DEFLECTOR TO CEILING DISTANCE

13 GPM

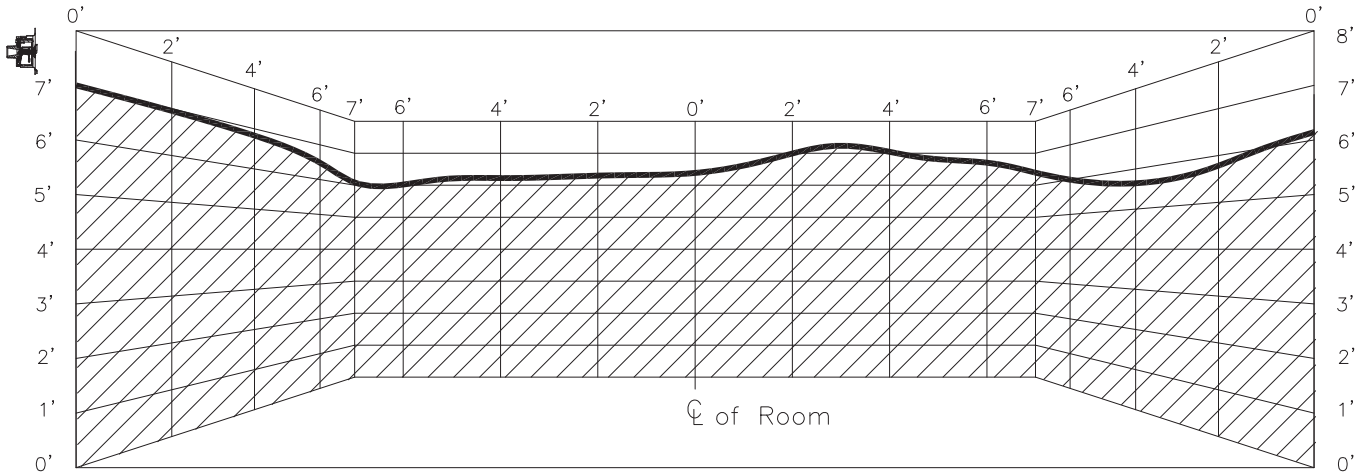

RFS42_HSW-14x14-12

NOMINAL WETTING PATTERN
 14ft.x14ft. COVERAGE AREA
 6"-12" DEFLECTOR TO CEILING DISTANCE

14 GPM

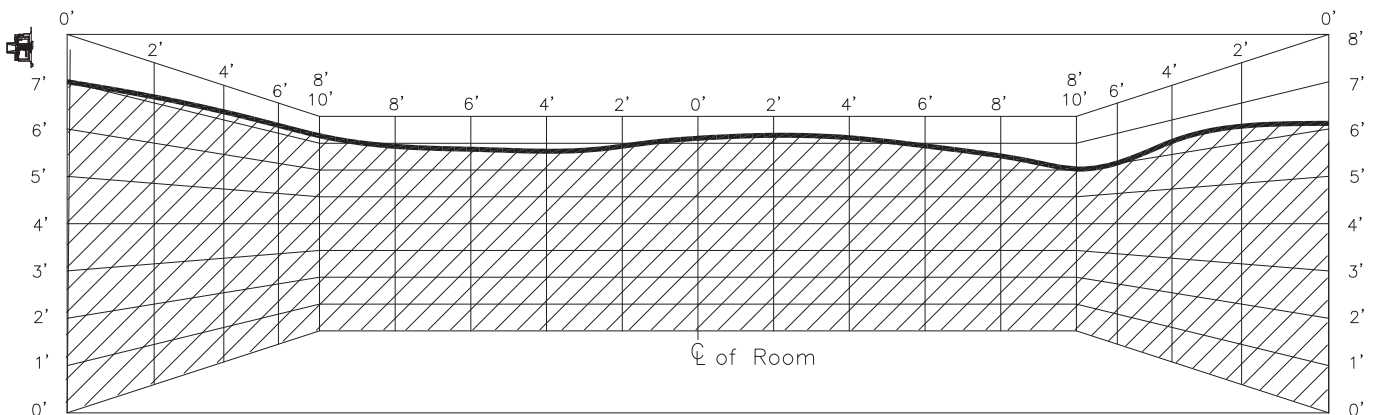

RFS42_HSW-16x20-12

NOMINAL WETTING PATTERN
 16ft.x20ft. COVERAGE AREA
 6"-12" DEFLECTOR TO CEILING DISTANCE

23 GPM

RFS 42 Flat HSW (cont.):

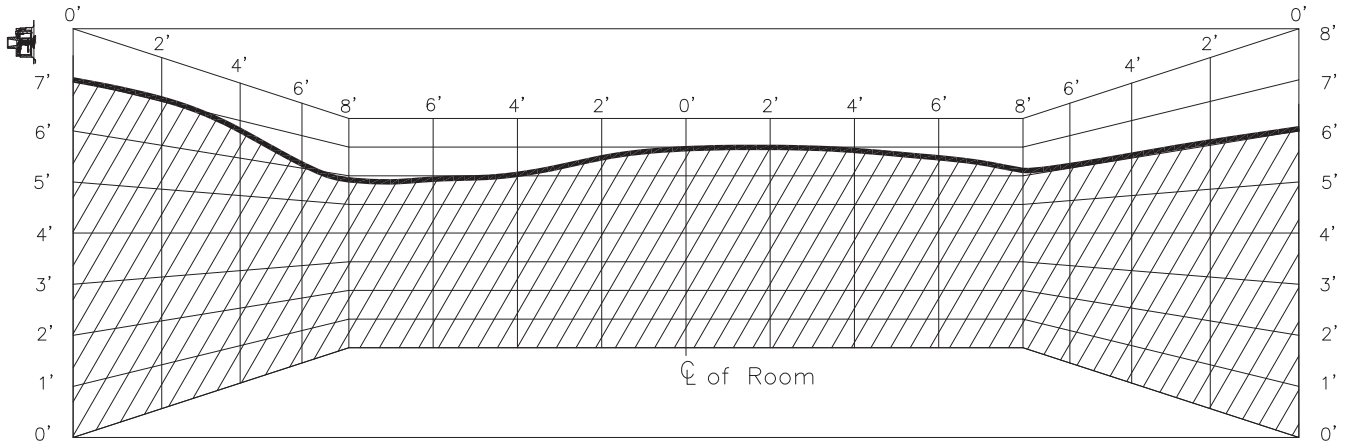

RFS42_HSW-16x16-12

NOMINAL WETTING PATTERN
 16ft.x16ft. COVERAGE AREA
 12" DEFLECTOR TO CEILING DISTANCE

16 GPM

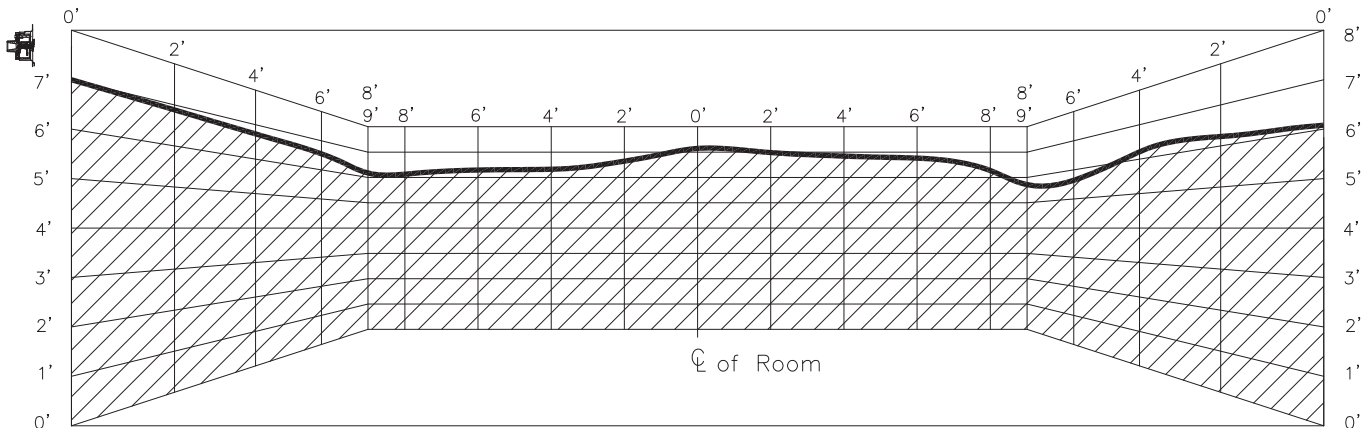

RFS42_HSW-16x18-12

NOMINAL WETTING PATTERN
 16ft.x18ft. COVERAGE AREA
 12" DEFLECTOR TO CEILING DISTANCE

18 GPM

The equipment presented in this bulletin is to be installed in accordance with the latest published Standards of the National Fire Protection Association, Factory Mutual Research Corporation, or other similar organizations and also with the provisions of governmental codes or ordinances whenever applicable. Products manufactured and distributed by Reliable have been protecting life and property for over 80 years, and are installed and serviced by the most highly qualified and reputable sprinkler contractors located throughout the United States, Canada and foreign countries.

Manufactured by



Reliable Automatic Sprinkler Co., Inc.

(800) 431-1588 Sales Offices
 (800) 848-6051 Sales Fax
 (914) 829-2042 Corporate Offices
 www.reliablesprinkler.com Internet Address



Revision lines indicate updated or new data.

EG. Printed in U.S.A. 07/15 P/N 9999970262