

# Reliable<sup>®</sup>

## QRM2- Series

Riser and Tank Mounted  
Quiet Oil-less Air Compressors  
**Installation, Operation and  
Maintenance Manual  
For 60Hz Models Only**

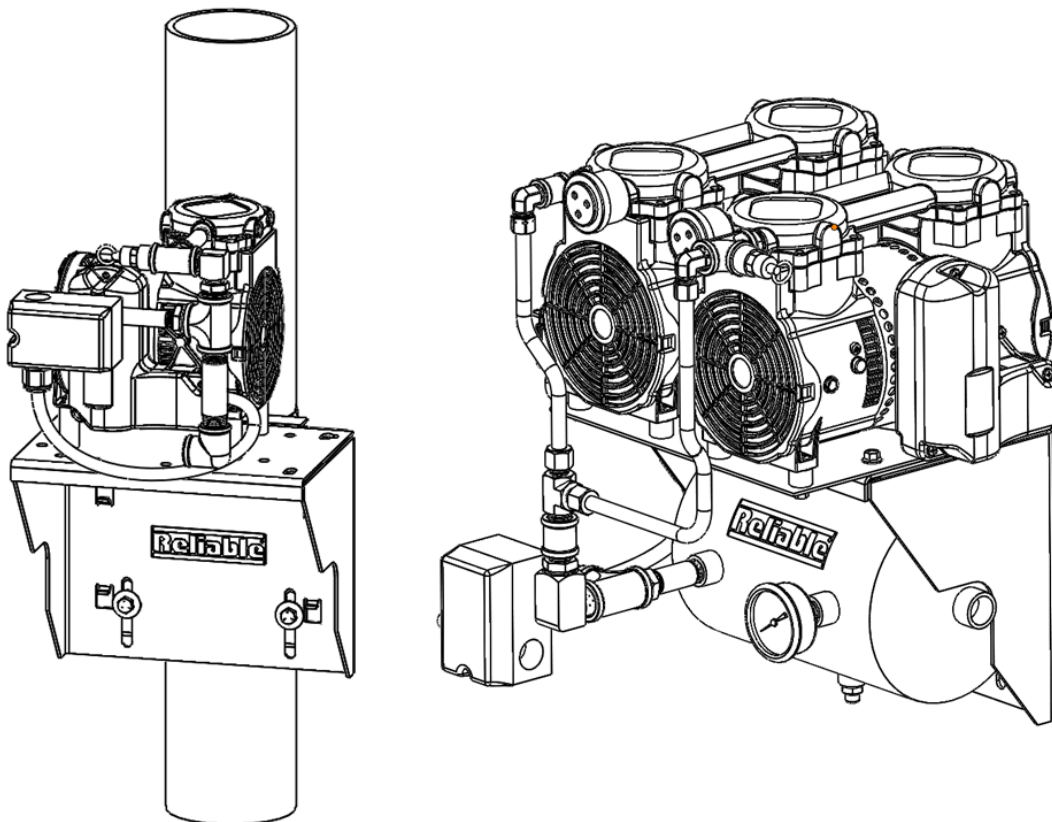

**Reliable Automatic Sprinkler Co., Inc.**  
103 Fairview Park Drive, Elmsford, New York 10523  
800-55-RASCO (800-557-2726) Technical Support  
[www.reliablesprinkler.com](http://www.reliablesprinkler.com)



# Table of Contents

## **Section 1 - Safety & Warnings**

- 1.1 - Safety Guidelines
- 1.2 - General Information
- 1.3 - General Safety Information
- 1.4 - Safety Notes

## **Section 2 - Receiving**

## **Section 3 - Installation Location**

## **Section 4 - Mounting**

- 4.1 - General Information
- 4.2 - Basic Instructions - Riser Mounting Bracket
- 4.3 - Basic Instruction - QRM2- Mounting Bracket

## **Section 5 - Lubrication**

## **Section 6 - Piping**

- 6.1 - Piping Instructions
- 6.2 - QRM2- Series Riser Mounted Quiet Oilless Air Compressor Installation Drawing
- 6.3 - QRM2-T Series Tank Mounted Quiet Oilless Air Compressor Installation Drawing

## **Section 7 - Wiring**

- 7.1 - Wiring Instructions
- 7.2 - Oilless Air Compressor Single Phase Wiring Drawing

## **Section 8 - Adjusting the Pressure Switch**

- 8.1 Oil Less Air Compressor: 20/26 PSIG Riser Mount and 60/80 PSIG Tank Mount
- 8.2 Oil Less Air Compressor: 40/50 PSIG Riser Mount

## **Section 9 - Maintenance Instructions**

## **Section 10 - Troubleshooting Guide**

## **Section 11 - Warranty Policy**

# Section 1 - Safety & Warnings

## 1.1 Safety Guidelines

This manual contains information that is very important to know and understand. This information is provided for SAFETY and to PREVENT EQUIPMENT PROBLEMS. To help recognize this information, observe the following symbols.



- Danger indicates an imminently hazardous situation which, if not avoided, **WILL** result in death or serious injury.



- Warning indicates a potentially hazardous situation which, if not avoided **COULD** result in death or serious injury.



- Caution indicates a potentially hazardous situation which, if not avoided, **MAY** result in minor or moderate injury.



- Notice indicates important information, that if not followed may cause damage to equipment.

## 1.2 General Information

This compressor is intended for installation indoors for use on dry sprinkler systems in accordance with the Standard for Installation of Sprinkler Systems, NFPA 13 and the National Electrical Code, NFPA 70. The compressor should be sized to restore and maintain the air pressure in the sprinkler system in accordance with the requirements in NFPA 13.

## 1.3 General Safety Information

1. Read all manuals included with this product carefully. Be thoroughly familiar with the controls and the proper use of the equipment.
2. Follow all local electrical and safety codes as well as National Electrical Codes (NEC), Occupational Safety and Health Act (OSHA), and National Fire Protection Association (NFPA).
3. Only persons familiar with these rules of safe operation should be allowed to use the equipment.
4. Keep visitors away and NEVER allow children in the work area.
5. Wear safety glasses and use hearing protection when operating the unit.
6. Do not stand on or use the unit as a handhold.
7. **Periodic inspection and test of this equipment is required.** Consult your installer and local codes to meet all requirements.
8. Check all fasteners at frequent intervals for proper tightness.

## 1.4 Safety Notes



- This compressor is not equipped and should NOT be used "as is" to supply breathing quality air.



- Motors, electrical equipment and controls can cause electrical arcs that will ignite flammable gas or vapor. Never operate or repair in or near flammable gas or vapor. Never store flammable liquids or gasses near the compressor.



- These compressors are suitable for pumping only atmospheric air. As defined in Compressed Gas Association Pamphlet G-7, page 3, atmospheric air is a mixture of elements and compounds where nitrogen and oxygen comprise more than 99% with all other trace gasses comprising less than 1%. **Do not use this compressor in contaminated environments or for pumping mixtures other than atmospheric air.**



- Compressed air contains liquid water and is saturated with water vapor, which can freeze when surrounding temperatures are lower than 32°F (0°C). Component selection to minimize the effects of water vapor must be considered.



- Do not touch any component inside compressor enclosure or on the discharge piping when the compressor is operating or immediately after it has stopped. The components are extremely hot and can cause severe injury. Before servicing the compressor, disconnect the power and wait for its components to cool down.

## Section 2 - Receiving

Your compressor is inspected at the factory and packaged to protect against shipping damage. When the compressor is unpacked, inspect for damage or missing parts. All claims should be settled directly with the freight company.



- Do not operate this compressor if damaged during shipment, handling or use. Any damage may result in failure and cause injury or property damage.

## Section 3 - Installation Location

Locate the compressor in a clean, well ventilated area where air is relatively cool, clean and dry. A 104°F (40°C) maximum and 40°F (4°C) minimum temperature for surrounding and inlet air are recommended. Provide at least 12 to 18 inches of clearance from any wall or other obstruction that will interfere with airflow over and through the compressor. Blocking airflow through the fan may cause the compressor to overheat. Do not place the compressor in an area of excessive heat, such as near a boiler.

## Section 4 - Mounting

### 4.1 General Information

QRM2- Series Riser mounted units may be mounted to a fire sprinkler system riser with a riser mounting bracket. A riser mounting bracket and (3) straps are provided. Both tank and tank-less riser mounted units should be connected with a flex hose (Ordered Separately). The flex hose (P/N 6872000000) must be installed between the compressor or tank outlet and service piping.

The compressor must be mounted in a flat, level, horizontal orientation. The “L” shaped bracket is provided to ensure this. The compressor is shipped mounted to the “L” bracket using metal spacers. This can then be directly mounted and fastened to the flat riser bracket provided with straps.

## 4.2 Basic Instructions - Riser Mounting Bracket

### Riser Mounting Kit (RMK) Contents:

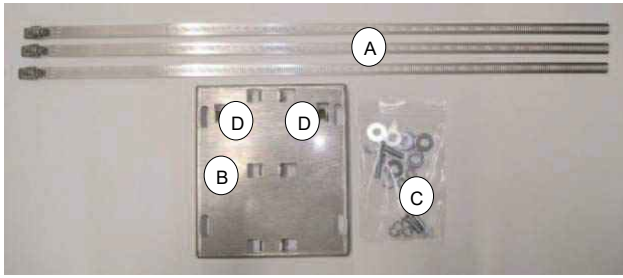

**A - Mounting Straps:** Each RMK comes with 3 mounting straps.

**B - Riser Mounting Plate**

**C - Nuts, Bolts, and Washers.**

Necessary for mounting the QRM2- Bracket.

**D - Mounting Hooks**

### Riser Mounting Kit (RMK) Mounting:

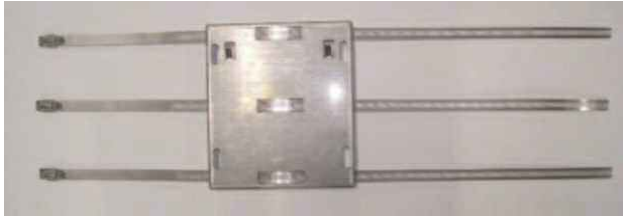

Bring the mounting straps in from the back side through the left hole. Pass over the front of the Plate and put the strap through the right. Repeat for straps **2** and **3**.



Ensure that the hooks are at the top when installed and that all three straps are fastened tight against the riser (no slack).

**Straps must be 90° angle to riser for proper installation.**

**IMPORTANT NOTE:** Torque straps screws to **35 to 40 in - lbs**.

## 4.3 Basic Instructions – QRM2- Mounting Bracket

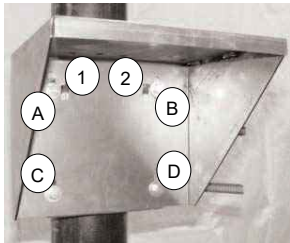

**1 & 2** - Use the rectangular holes on the bracket to rest it on the riser plate hooks.

**A, B, C, D** - Securely fasten the QRM2- compressor bracket to the riser plate through the slots using the hardware from the RMK (riser mounting kit). A socket extension may be required to insert the bolts.

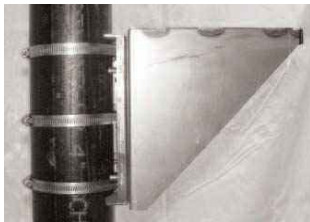

**IMPORTANT NOTE:** Torque bolts to **12 ft - lbs**

Before mounting the compressor, check that the top surface of the QRM2- bracket is level and parallel to the top edge of the riser plate.

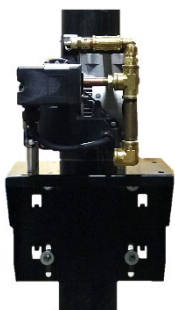

The compressor comes factory mounted to the compressor bracket. **NOTE:** Each QRM2- model has different mounting feet. Mounting holes for all compressors are provided on the QRM2- bracket.

**IMPORTANT NOTE:** Torque compressor mounting bolts to **12 ft - lbs**

## Section 5 - Lubrication



- This compressor is designed for non-lubricated service. Bearings are permanently lubricated. **Do not lubricate any part of the compressor or motor.**

## Section 6 - Piping

### 6.1 Piping Instructions



- Compressed air contains liquid water and is saturated with water vapor, which can freeze when surrounding temperatures are lower than 32°F (0°C). Component selection to minimize the effects of water vapor must be considered.

Piping between the compressor, accessory items and the sprinkler system must be at least ½" internal diameter to minimize pressure drop from the compressor to system. Larger pipe size may be required by code and may be substituted with no adverse effects.



- Smaller line size must not be used and will restrict the compressor flow, lowering capacity and causing the compressor/motor to work harder, which shortens compressor/motor life. All piping connected to the compressor must be fully supported and not transfer any loads to the compressor.

If an air maintenance device (AMD) is used, allow sufficient distance between the compressor and AMD to ensure that the maximum temperature at the AMD is 200°F or less.



- An AMD must be used with all riser mounted tank units.

All oilless compressors include a relief valve which is installed on the compressor. This valve will open at a preset value above the pressure switch setting to prevent excess pressure in the event of a switch failure.



- Do not attempt to change the safety relief valve setting.

A manual drain is provided on the bottom of each riser mount model with a tank. Moisture accumulated in the tank must be drained weekly.

The compressor outlet piping should contain an accessible drain. As a minimum a manual drain may be used, but an automatic drain is recommended to remove excess water.



- Accumulation of condensed water in the system can cause corrosion of components and reduction of system capacity.



- Warranty is void if a separate check valve is not installed to prevent water backflow to compressor.

### Optional Flex Hose Installation Instructions:

An optional 30 inch Stainless Steel flex hose is available to aid the air compressor installation. Part number 6872000000 should be ordered if desired. The flex hose has ½" NPT male threads on both ends. Attach the flex hose to the air compressor discharge or the air tank first. Then install a union to connect it to the piping system.



# Section 6 - Piping

## 6.2 QRM2- Series Riser Mounted Oil Less Air Compressor Installation Drawing

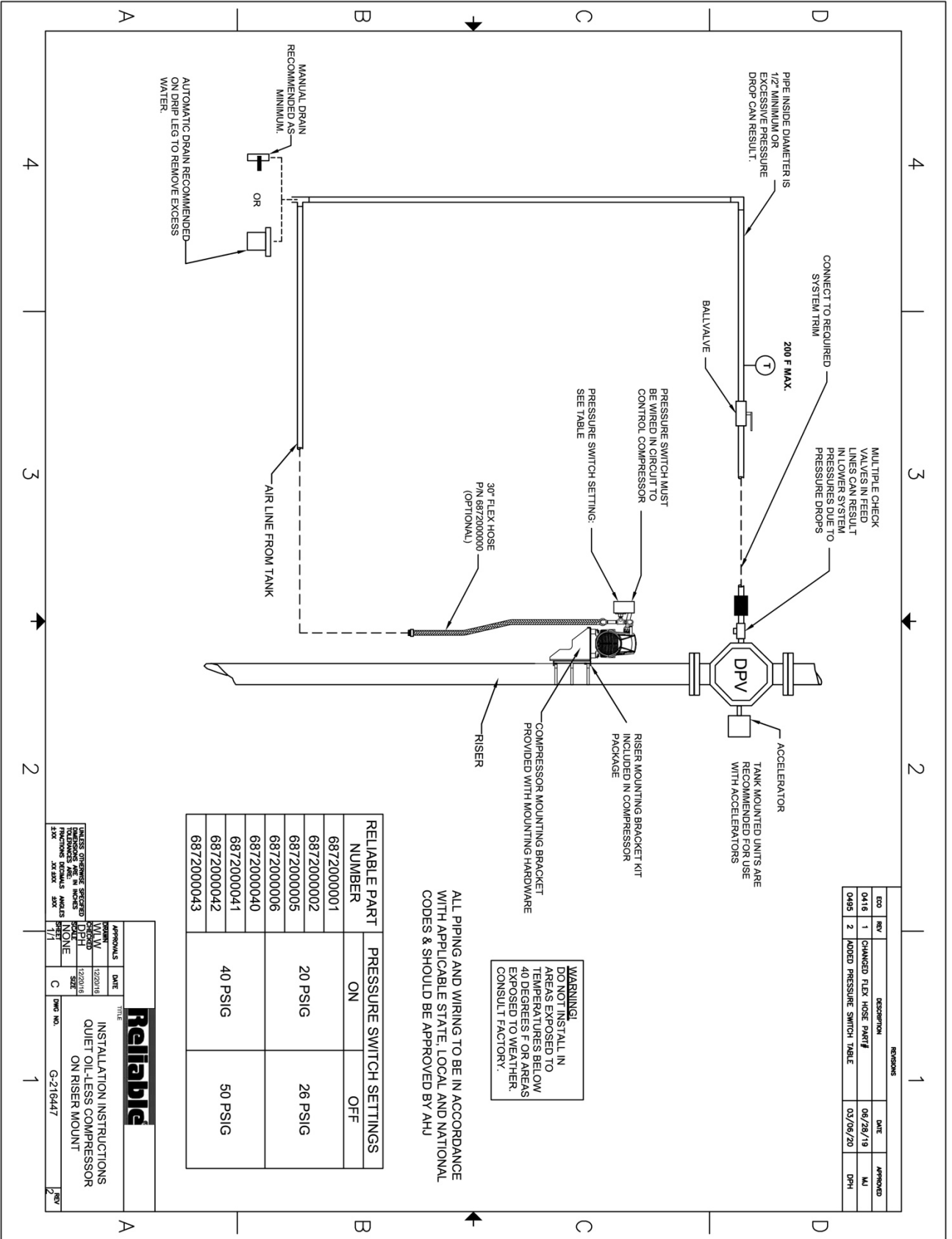

RELIABLE PART NUMBER	PRESSURE SWITCH SETTINGS	
	ON	OFF
6872000001		
6872000002		
6872000005	20 PSIG	26 PSIG
6872000006		
6872000040		
6872000041		
6872000042	40 PSIG	50 PSIG
6872000043		

ALL PIPING AND WIRING TO BE IN ACCORDANCE WITH APPLICABLE STATE, LOCAL AND NATIONAL CODES & SHOULD BE APPROVED BY AHJ

**WARNING!**  
DO NOT INSTALL IN AREAS EXPOSED TO TEMPERATURES BELOW 40 DEGREES F OR AREAS EXPOSED TO WEATHER. CONSULT FACTORY.

REVISIONS				
ECO	REV	DESCRIPTION	DATE	APPROVED
0416	1	CHANGED FLEX HOSE PART#	06/28/19	MM
0495	2	MOVED PRESSURE SWITCH TABLE	03/08/20	DPH

**Reliable**

INSTALLATION INSTRUCTIONS  
QUIET OIL-LESS COMPRESSOR  
ON RISER MOUNT

APPROVALS	DATE	TITLE
MM	12/20/16	
DPH	12/20/16	
NONE		

UNLESS OTHERWISE SPECIFIED, TOLERANCES ARE: ANGLES: 30X  
DIM: 1/16  
DIM: 1/16

REV C DWG NO. G-216447



# 6.3 QRM2-T Series Tank Mounted Oil Less Air Compressor Installation Drawing

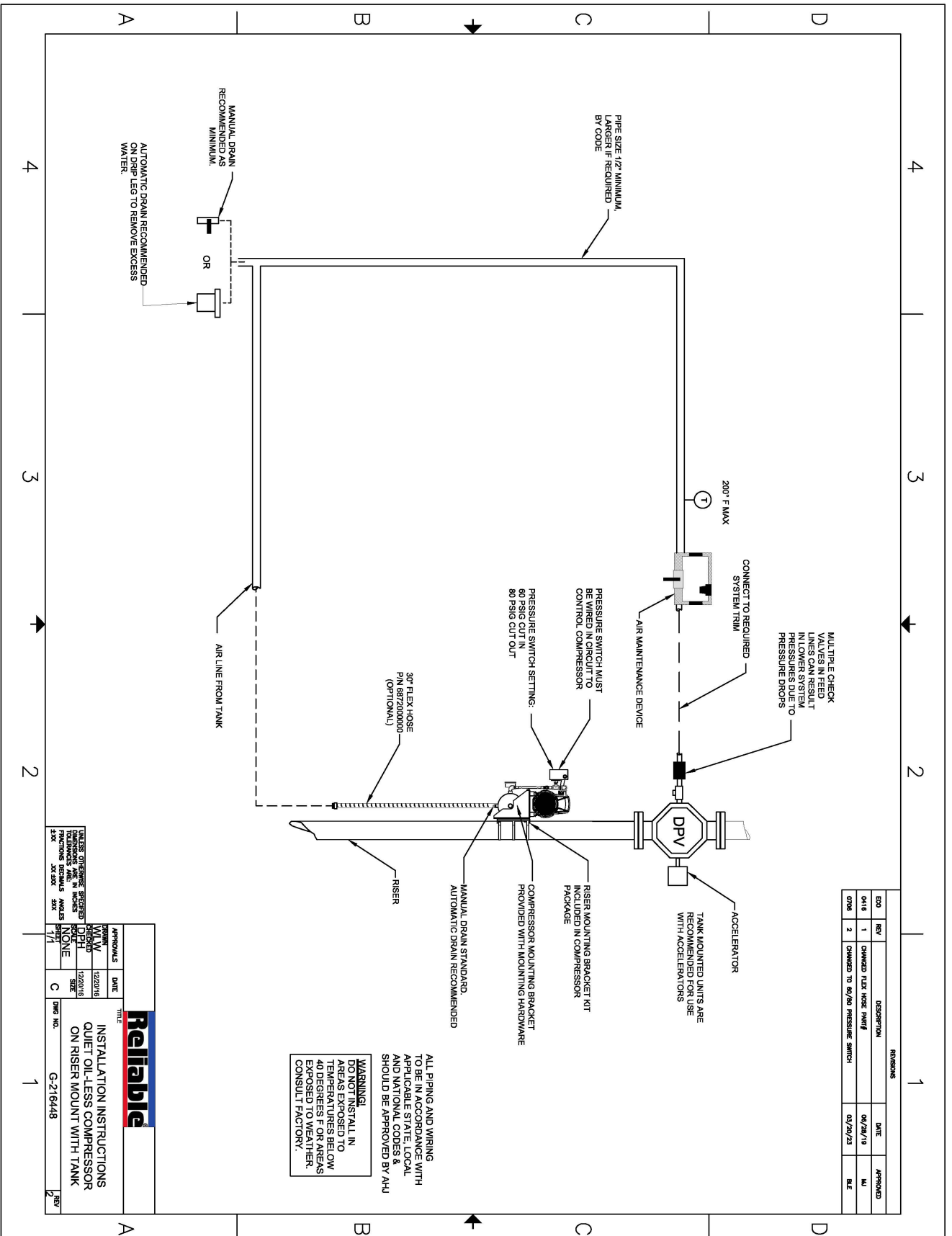

# Section 7 - Wiring

## 7.1 Wiring Instructions



- Wiring should be in accordance with the National Electrical Code (NEC) and any local codes or regulations. Have a licensed and competent electrician ensure that the voltage supplied matches the compressor voltage.



- Inadequate wiring size can cause insufficient voltage at the compressor during start-up. Overheating and damage can result to the motor and controls.



- Failure to use the pressure switch may result in overpressure of the compressor or other components in the system. Overpressure of the compressor can result in blown head gaskets or other damage.



- Grounding Instructions: This product must be connected to a grounded, metallic, permanent wiring system, or an equipment grounding terminal or lead on the product.

The supply wire must be of adequate size and no other equipment should be connected to the same line. The adjacent table lists the recommended wire size for each model based on a 100' run and lowest operating voltage. Consult factory for longer runs.



- Single-phase motors include internal thermal overload protection, which has an automatic reset device.



- Disconnect electrical power before servicing to disable reset devices. Thermal protection can automatically start the motor when the protector resets.

The motor is pre-wired to the pressure switch provided, which controls starting (cut-in pressure) and stopping (cut-out pressure) of the motor. The pressure switch is factory set. Tank-less riser mount models have the switch set at 20 cut-in and 26 psig cut-out. Riser Mount with Tank have the switch set at 60 psig cut-in and 80 psig cut-out.

Minimum Recommended Wire Size	
60Hz Model #	1 Phase
QRM2-25115	12
QRM2-25115-40/50	12
QRM2-25220	12
QRM2-25220-40/50	12
QRM2-25115T	12
QRM2-25220T	12
QRM2-50115	12
QRM2-50115-40/50	12
QRM2-50220	12
QRM2-50220-40/50	12
QRM2-50115T	12
QRM2-50220T	12
QRM2-100115T	12
QRM2-100220T	12

**A motor starter can be used, for all single-phase models.** Consult the National Electric Code and local codes for motor starter requirements. Refer to the proper wiring instruction drawing for recommended wiring to a starter.

# 7.2 Oil Less Air Compressor Single Phase Wiring Drawing

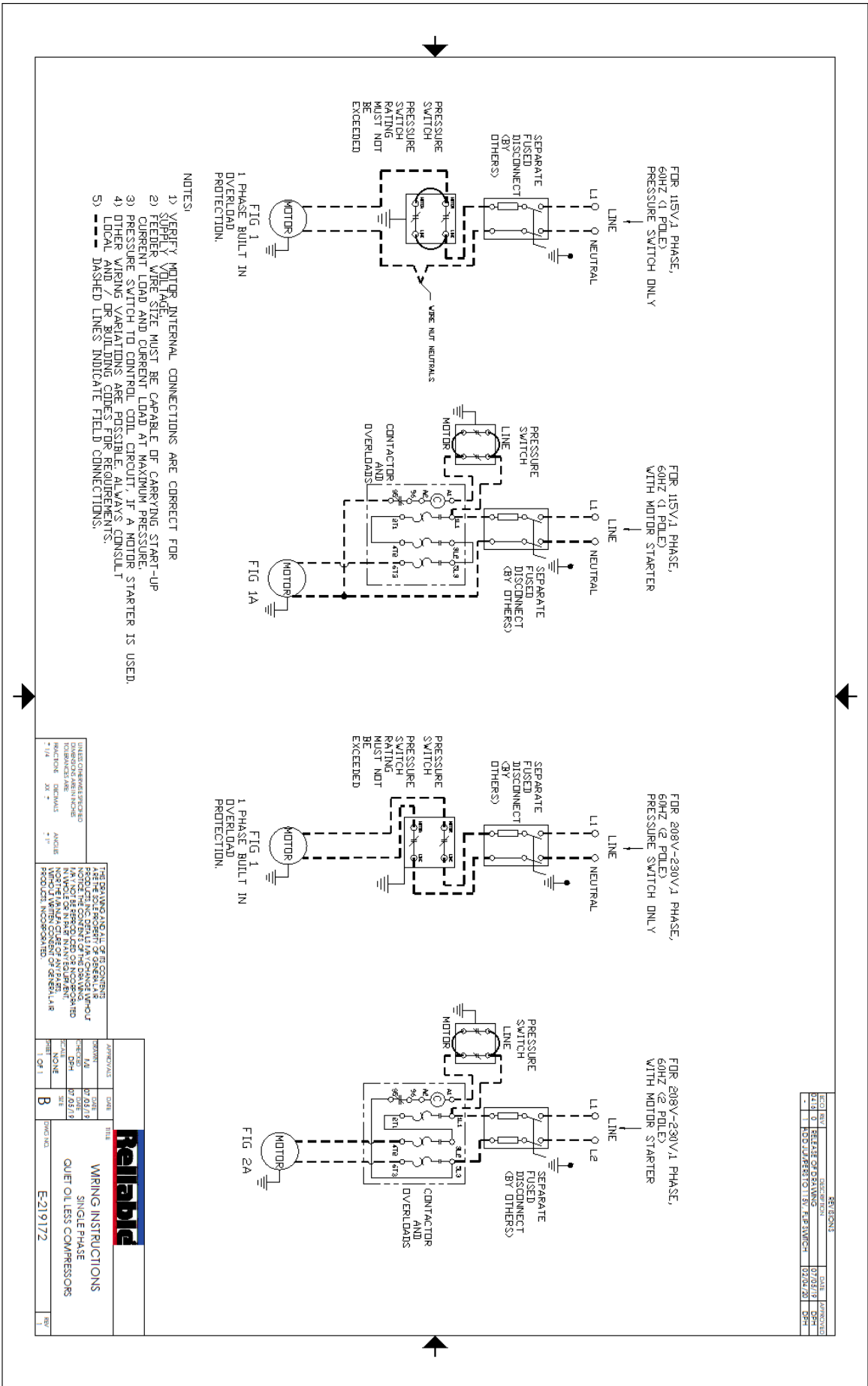

# Section 8 - Adjusting the Pressure Switch

## 8.1 Oil Less Air Compressor: 20/26 PSIG Riser Mount and 60/80 PSIG Tank Mount

**STEP 1:** Adjust the cut-in and cut-out pressure by turning the **Main Calibration Screw**; clockwise to increase pressure, counter-clockwise to decrease pressure.

**STEP 2:** Adjust the **Differential Pressure Screw** to change the cut-out pressure without affecting the cut-in pressure\*. Clockwise increases pressure, counter-clockwise decreases pressure.

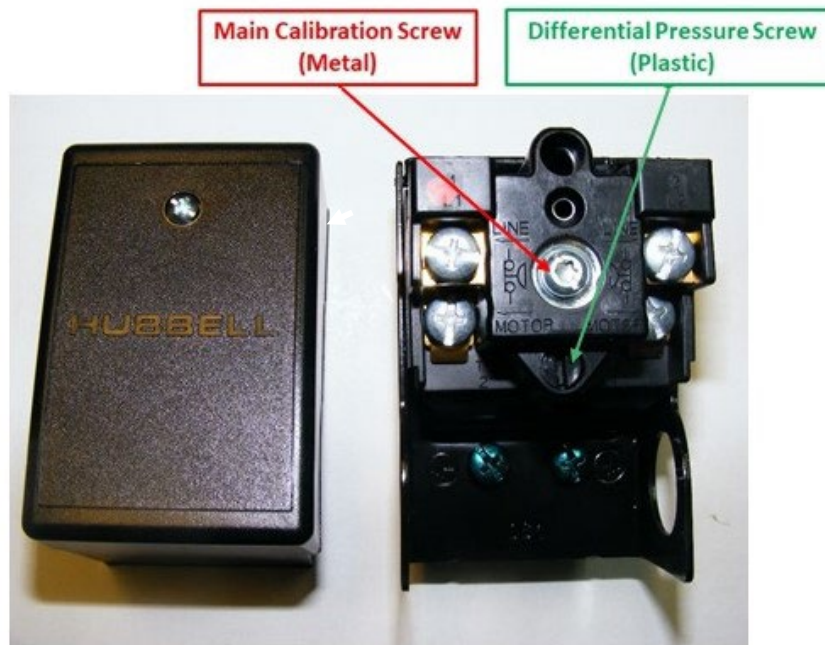

QRM2- Models with Tank

(RASCO Part Number 6990028654)

Factory Set at 60 PSIG Cut-IN / 80 PSIG Cut-OUT

QRM2- Models without Tank

(RASCO Part Number 6990021904)

Factory Set at 20 PSIG Cut-IN / 26 PSIG Cut-OUT

\*Differential Pressure is defined as the difference between cut-out and cut-in pressure. Turning the differential pressure screw clockwise increases the differential pressure, which increases the cut-out pressure without changing the cut-in pressure.

## 8.2 Oil Less Air Compressor: 40/50 PSIG Riser Mount

STEP 1: Adjust both cut-in and cut-out pressure by turning the Main Calibration Screw; clockwise to increase pressure, counter-clockwise to decrease pressure. Tip: Adjust to desired cut-in pressure first.

STEP 2: Adjust the Differential Pressure Screw to change the cut-out pressure without affecting the cut-in pressure\*. Clockwise increases pressure, counter-clockwise decreases pressure.

**Main Calibration Screw**

**Differential Pressure Screw**

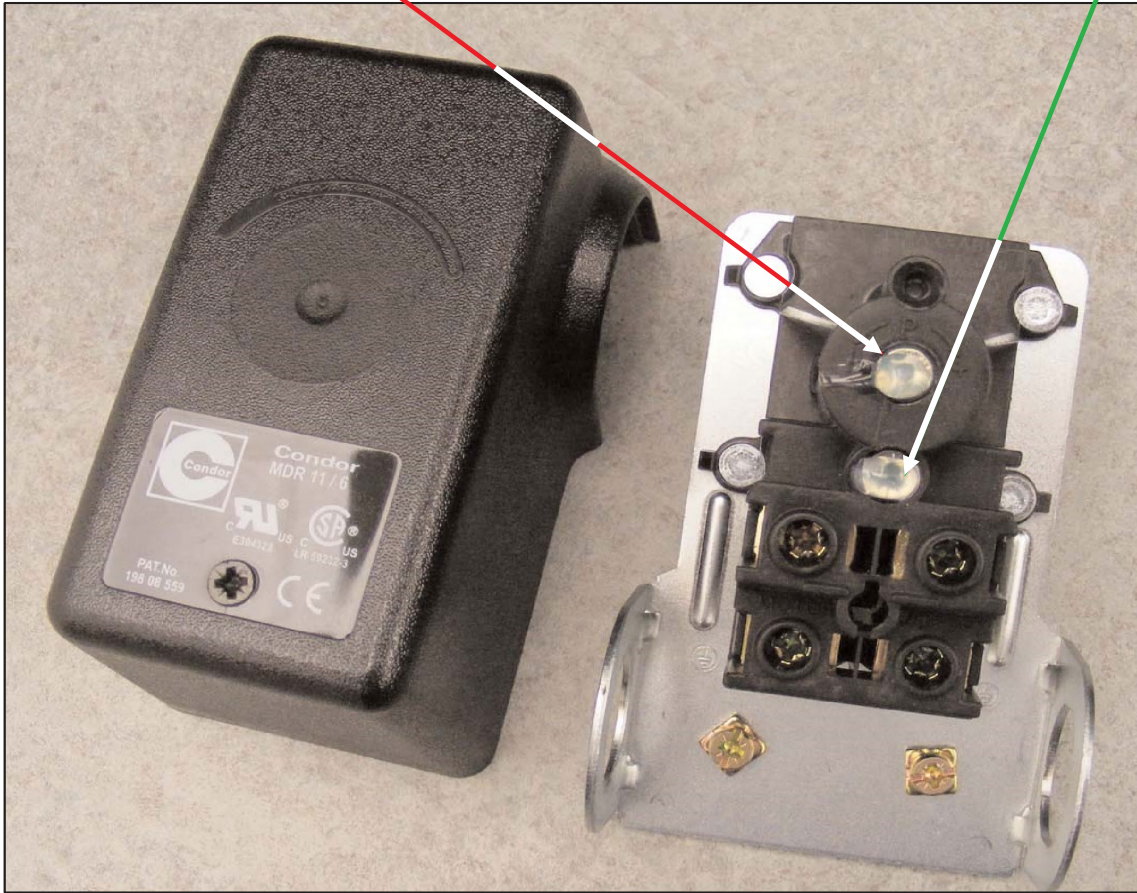

QRM2- 40/50 Models without Tank

(RASCO Part Number 6990024483)

Factory Set at 40 PSIG Cut-IN / 50 PSIG Cut-OUT

### QRM2 Replacement Parts

<b>Pressure Switch</b>	<b>Without Tank</b> (20 psig on/26 psig off)	<b>Reliable P/N 6990021904</b>
	<b>Without Tank</b> (40 psig on/50 psig off)	<b>Reliable P/N 6990024483</b>
	<b>With Tank</b> (60 psig on/80 psig off)	<b>Reliable P/N 6990028654</b>
<b>Check Valve</b>	<b>Without Tank</b>	<b>Reliable P/N 6990021906</b>
	<b>With Tank</b>	<b>Reliable P/N 6990021906</b>

## Section 9 - Maintenance Instructions



- Disconnect, tag, and lock out power source then release all pressure from the system before attempting to install, service, relocate, or perform any service.

The following instructions are based on normal operation. If the compressor is in an excessively dusty area, increase frequency of maintenance checks.

### Weekly:

- Drain condensate from receiver and traps
- Check for unusual noise or vibration
- Clean all external parts of the compressor and motor

### Monthly:

- Manually test safety relief valve
- Inspect air system for leaks
- Tighten fitting, nuts, and screws as required

**Note: The QRM2- air filter does not need to be checked or changed except at time of compressor overhaul – approximately 8,000 hours of operation.**

## Section 10 - Troubleshooting Guide

Symptom	Possible Cause(s)	Corrective Action
Motor hums and runs slowly or not at all.	<ol style="list-style-type: none"> <li>1. Low or no voltage</li> <li>2. Shorted or open motor winding</li> <li>3. Defective check valve</li> <li>4. Defective pressure switch - contacts will not close</li> </ol>	<ol style="list-style-type: none"> <li>1. Check voltage during start. Voltage must be within +/- 10% of nominal voltage to start motor. Increase wire size if necessary, to lower voltage drop.</li> <li>2. Replace compressor</li> <li>3. Replace check valve</li> <li>4. Repair or replace pressure switch</li> </ol>
Reset mechanism cuts out or fuses blow repeatedly	<ol style="list-style-type: none"> <li>1. Insufficient voltage to motor</li> <li>2. Pressure switch set too high</li> <li>3. Wrong fuse size</li> <li>4. Piping too restrictive</li> <li>5. Defective motor</li> </ol>	<ol style="list-style-type: none"> <li>1. Check voltage during start. Voltage must be within +/- 10% of nominal voltage to start motor. Increase wire size if necessary, to lower voltage drop.</li> <li>2. Consult factory, adjust or replace</li> <li>3. Be sure fuses, heaters and/or overloads are properly rated or set</li> <li>4. Add receiver vessel or increase pipe volume after compressor</li> <li>5. Consult factory</li> </ol>
Unit short cycles repeatedly	<ol style="list-style-type: none"> <li>1. Piping too restrictive</li> <li>2. Air leaks</li> </ol>	<ol style="list-style-type: none"> <li>1. Add receiver vessel or increase pipe volume after compressor</li> <li>2. Repair leaks</li> </ol>
Compressor overheating	<ol style="list-style-type: none"> <li>1. Dirty intake filter</li> <li>2. Wrong motor rotation</li> <li>3. Air flow to fan blocked</li> </ol>	<ol style="list-style-type: none"> <li>1. Clean intake filter</li> <li>2. Correct rotation</li> <li>3. Clean air flow to fan or relocate unit</li> </ol>
Excessive noise in operation	<ol style="list-style-type: none"> <li>1. Damaged bearings</li> <li>2. Worn piston cup</li> <li>3. Broken valves</li> <li>4. Loose fan</li> <li>5. Damaged fan guard</li> </ol>	Contact Reliable for technical support
System pressure builds slowly	<ol style="list-style-type: none"> <li>1. Compressor sized incorrectly</li> <li>2. Leaks or restrictions in piping</li> <li>3. Dirty intake filter</li> </ol>	<ol style="list-style-type: none"> <li>1. Check system size and compressor sizing</li> <li>2. Correct leaks and remove restrictions</li> <li>3. Clean intake filter</li> </ol>

# Section 11 - Warranty Policy

## GENERAL PROVISIONS & LIMITATIONS

Reliable Automatic Sprinkler Co., Inc. (the "Company") warrants to each original purchaser ("Purchaser") of its new products from the Company or its Authorized Distributor that such products are, at the time of delivery to the Purchaser, made with good materials and workmanship. No warranty is made with respect to:

1. Any product, which has been repaired or altered in such a way, in the Companies judgment, as to affect the product adversely.
2. Any product, which has, in the Companies judgment been subjected to negligence, accident, improper storage, improper installation or application.
3. Any product, which has not been operated or maintained in accordance with the recommendations of the Company.
4. Components or accessories manufactured, warranted and serviced by others.
5. Any reconditioned or prior owned product.

Claims for items described in 4. above should be submitted directly to the manufacturer.

## WARRANTY PERIOD

The Company's obligation under this Warranty is limited to repair or, at its option, replacing during normal business hours at the designated facility of the Company, any part that in its judgment proved not to be as warranted within the applicable Warranty Period as follows.

## COMPONENTS

All non-consumable components are warranted for 12 months from the date of purchase. Consumables are not covered under warranty. The unit must have been installed by either a factory authorized distributor or agent in accordance with the factory recommendations taking into account all other local site conditions not originally noted to the factory. The unit must be operated and maintained in accordance with the Factory recommendations and original design conditions. Failure to provide such proof of the above may void warranty.

## LABOR TRANSPORTATION & INSPECTION

The Company will repair or replace any product or part thereof which in the Companies judgment is proved to be not as warranted. Labor costs are not covered under warranty.

All costs of transportation of product, labor or parts claimed not to be as warranted and, of repaired or replaced parts to or from factory shall be borne by purchaser. The Company may require the return of any part claimed not to be as warranted to one of its facilities as designated by the Company, transportation prepaid by Purchaser, to establish a claim under this warranty.

Replacement parts provided under the terms of the warranty are warranted for the remainder of the Warranty Period of the product upon which installed to the same extent as if such parts were original components.

## DISCLAIMER

THE FOREGOING WARRANTY IS EXCLUSIVE AND IT IS EXPRESSLY AGREED THAT, EXCEPT AS TO TITLE, THE COMPANY MAKES NO OTHER WARRANTIES, EXPRESSED OR IMPLIED OR STATUTORY, INCLUDING ANY IMPLIED WARRANTY OR MERCHANTABILITY.

THE REMEDY PROVIDED UNDER THIS WARRANTY SHALL BE THE SOLE, EXCLUSIVE AND ONLY REMEDY AVAILABLE TO THE PURCHASER AND IN NO CASE SHALL THE COMPANY BE SUBJECT TO ANY OTHER OBLIGATIONS OR LIABILITIES. UNDER NO CIRCUMSTANCES SHALL THE COMPANY BE LIABLE FOR SPECIAL, INDIRECT, INCIDENTAL OR CONSEQUENTIAL DAMAGES, EXPENSES, LOSSES OR DELAYS HOWSOEVER CAUSED.

No statement, representation, agreement, or understanding, oral or written, made by any agent, distributor, representative or employee of the Company which is not contained in this Warranty will be binding upon the company unless made in writing and executed by an officer of the Company.

This warranty shall not be effective as to any claim which is not presented within 30 days after the date upon which the product is claimed not to have been as warranted. Any action for breach of this warranty must be commenced within one year after the date upon which the cause of action occurred.

Any adjustment made pursuant to this warranty shall not be construed as an admission by the Company that any product was not as warranted.

## PROMPT DISPOSITION & RETURNS POLICY

The Company will make a good faith effort for prompt correction or other adjustment with respect to any product, which proves to be defective within the warranty period. Before returning any product, write or call the distributor, agent or authorized company from which the product was purchased, describing defect and giving date and number of original invoice, as well as proof of Factory supplied consumables and proof of scheduled maintenance. No products will be accepted for return without the Company issuing a "Returned Goods Authorization" (RGA) to the Purchaser and unless accompanied by a properly authorized RGA request form initiated by the Purchaser. Return freight must be prepaid and each returned product must have the RGA number clearly marked on the product. Title and risk of loss pass to buyer upon delivery to the common carrier.

## PRODUCT SUITABILITY

Many States, Localities and Countries have codes and regulations governing sales, construction, installation, and/or use of products for certain purposes, which may vary from those in neighboring areas. While Reliable Automatic Sprinkler Co., Inc. attempts to assure that its products comply with such codes, it cannot guarantee compliance, and cannot be responsible for how the product is installed or used? Before purchase and use of a product, please review the product application, and national and local codes and regulations, and be sure that the product, installation, and use will comply with them.

### **Reliable Automatic Sprinkler Co., Inc.**

103 Fairview Park Drive, Elmsford, New York 10523  
800-55-RASCO (800-557-2726) Technical Support  
[www.reliablesprinkler.com](http://www.reliablesprinkler.com)