



# HV Spray Nozzles

## High Velocity Spray Nozzles

Model HV – AS with Strainer

### Features

Dense, High Velocity Core of Water Spray  
Solid Uniform Fixed Pattern Spray  
Brass housing  
Minimum desired pressure – 50 psi  
Six (6) orifice sizes

### Approvals & Listings

Model HV spray nozzles are UL listed.

### Applications - Model HV

High Velocity Water Spray Nozzles are internal swirl plate and open type nozzles designed for use in fixed water spray or deluge systems for fire protection applications.

These nozzles produce a solid uniform and dense core of high velocity water spray for effective fire control. Nozzles are normally used to cool the surface as well as for extinguishments. Nozzles are typically used for deluge protection of special hazards such as oil filled transformers, switch-gear, chemical processing equipment, conveyor systems and flammable liquid storage areas.

A minimum desirable pressure to achieve effective spray patterns is 50 psi (3.45 bar) (3448 kPa). The water distribution patterns presented in the following graphs show the maximum effective axial distance from the nozzle. The spray patterns shown are for indoor applications. The system designer must consider wind velocity while designing systems for outdoor applications. Field obstructions affecting the spray pattern of the nozzles must be considered. The nozzles may be oriented in any position which is deemed necessary to cover the hazard.

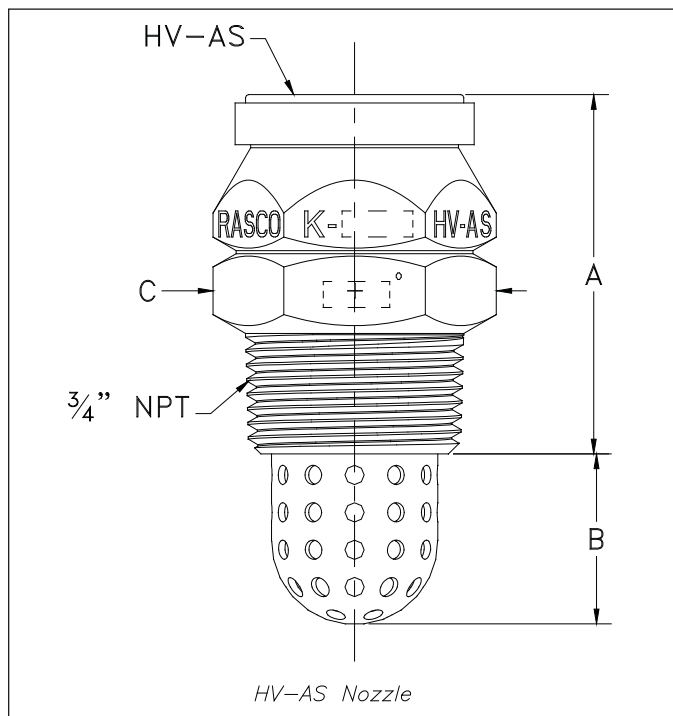

HV-AS Nozzle

### Technical Data

Model	Discharge Angle	K Factor (Metric)	Dimensions in inches (mm)		
			A	B	C
HV-AS	75°	1.54 (22)	1.93 (49)	0.83 (21)	1.18 (30)
	80°	1.26 (18)	1.73 (44)	0.83 (21)	1.18 (30)
	90°	2.24 (32)	1.93 (49)	0.83 (21)	1.18 (30)
	100°	1.82 (26)	2.16 (55)	0.83 (21)	1.18 (30)
	115°	2.94 (42)	1.93 (49)	0.83 (21)	1.18 (30)
	120°	1.61 (23)	1.93 (49)	0.83 (21)	1.18 (30)

### Pressure:

Rated: 175 psi (12 bar)

Working pressure range: 50 psi – to – 150 psi  
(3,4 bar – to – 10,3 bar)

**Note:** 1 bar = 100 kPa

Thread: 3/4" NPT

Material: Brass Housing

Finish: Brass (optional: Nickel – Chrome Plated)

Weight: Approximately 0.4 lb

### Ordering information:

- K Factor
- Discharge Angle
- Finish

## Maintenance

The spray nozzles must be handled carefully. For best results, the nozzle should be stored in the original packing in which it has been shipped. It is advised to ship the nozzle in the same packaging in future transit.

Nozzle which is visibly damaged should not be installed. Use Teflon tape or soft thread sealant on the male thread of the nozzle.

It is recommended that the water spray system be inspected by an authorized technical personnel. The nozzle must be checked for corrosion, external and internal obstruction, blockage if any. The nozzle should be cleared or replaced if required. The system must be operated with optimum water flow at least three times in a year or as per the provision of NFPA or the local authority having jurisdiction.

The owner is solely responsible for maintaining the water spray system and components therein, so that it performs properly in actual condition.

### DISCHARGE CHARACTERISTICS

PRESSURE IN PSI

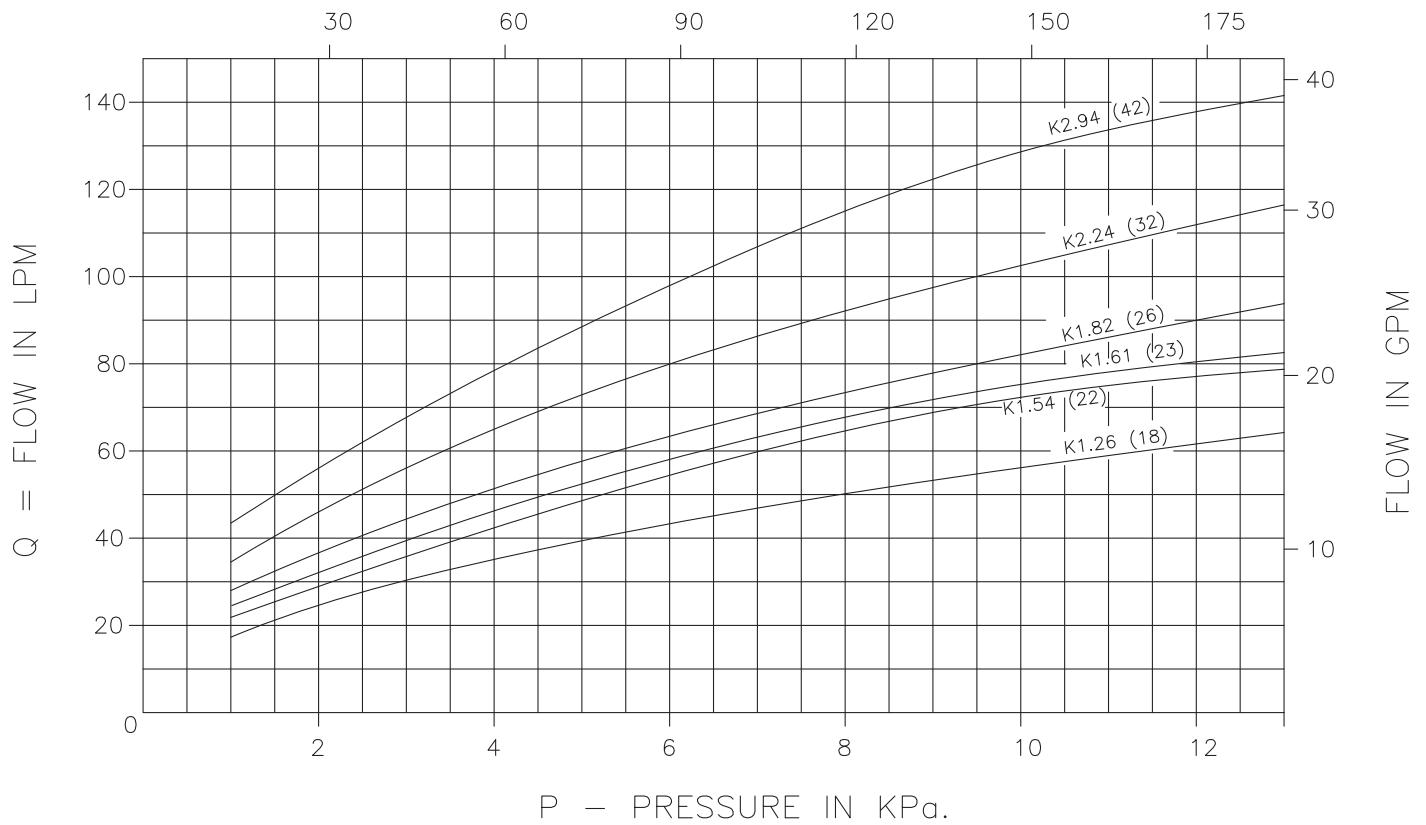

$Q = K\sqrt{P}$ , WHERE P IS SUPPLY PRESSURE IN KPa. & K IS NOZZLE CONSTANT.  
 K - NOZZLE CONSTANT WITH METRIC K FACTOR IN BRACKETS.

105\_DISCHARGE\_A

K22 X 75°

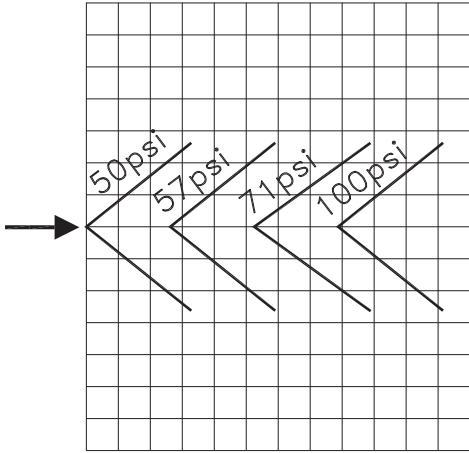

SPRAY HORIZONTAL  
EACH SQUARE = 12"

K18 X 80°

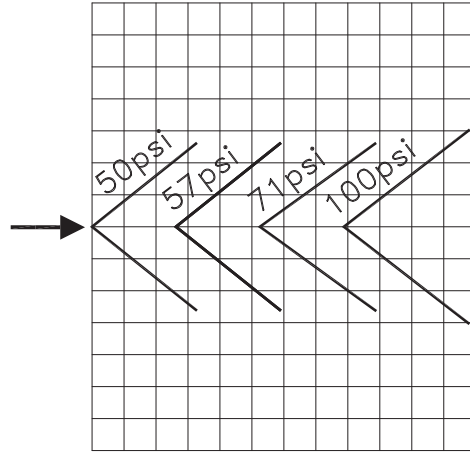

SPRAY HORIZONTAL  
EACH SQUARE = 12"

K32 X 90°

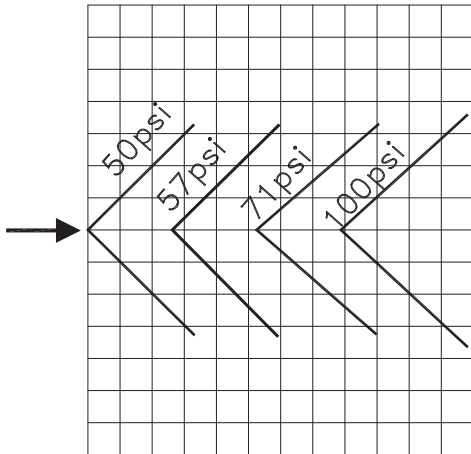

SPRAY HORIZONTAL  
EACH SQUARE = 12"

K42 X 115°

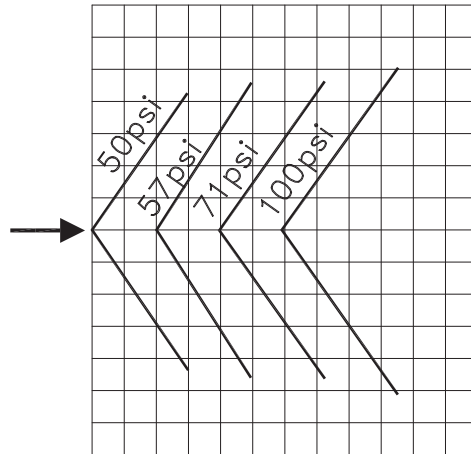

SPRAY HORIZONTAL  
EACH SQUARE = 12"

K23 X 120°

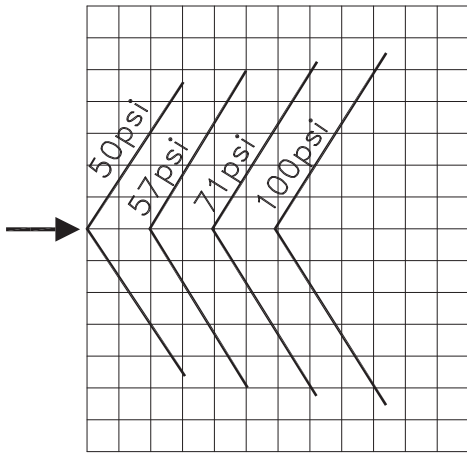

SPRAY HORIZONTAL  
EACH SQUARE = 12"

K26 X 100°

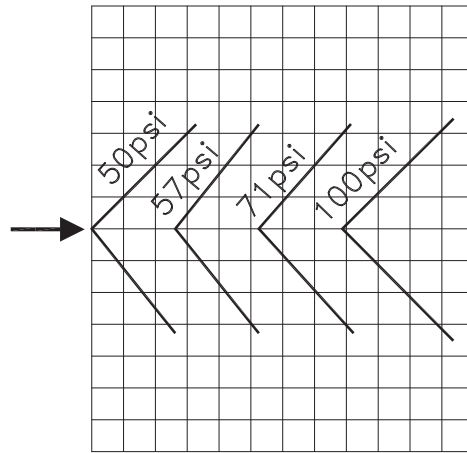

SPRAY HORIZONTAL  
EACH SQUARE = 12"

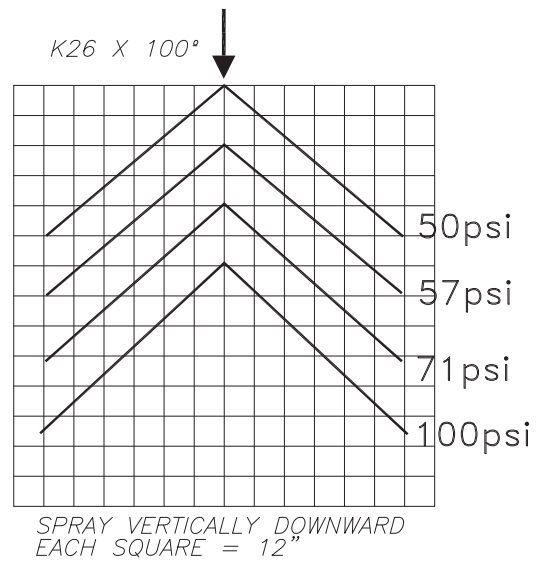
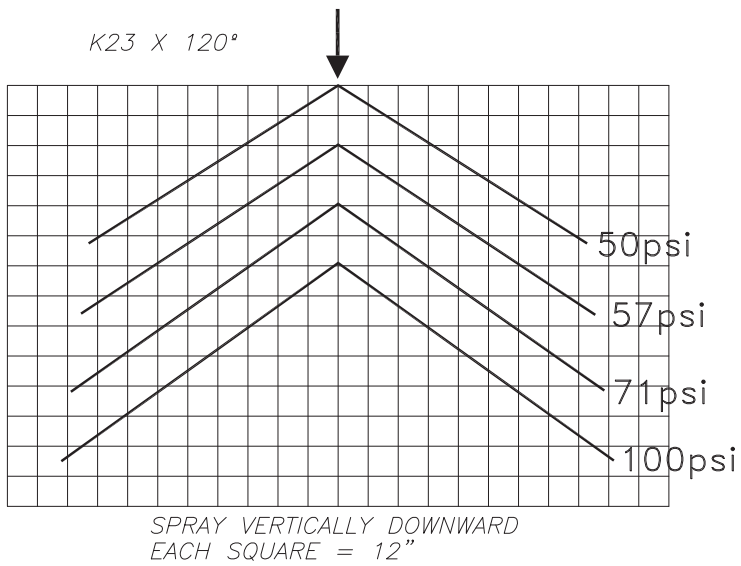
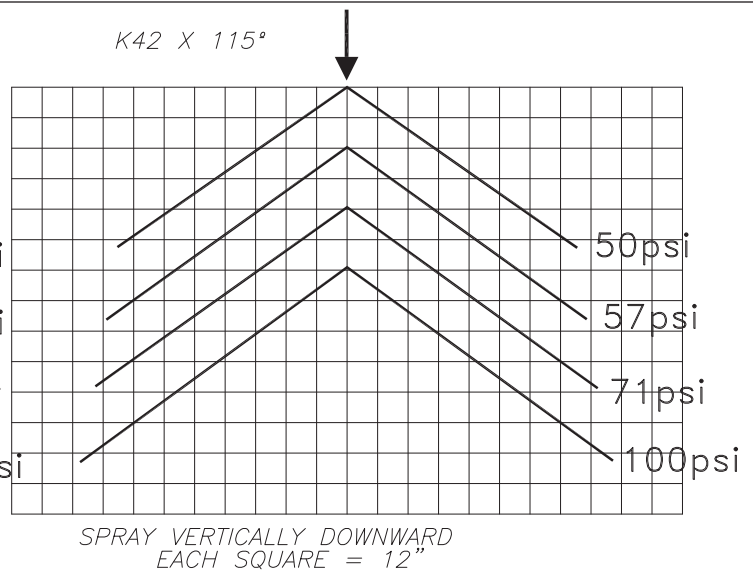
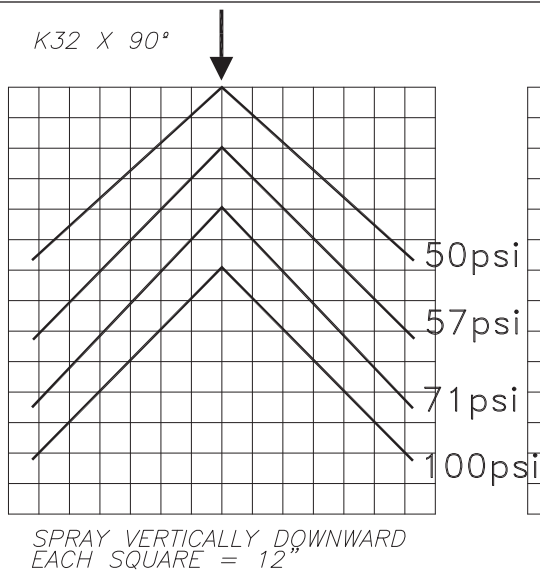
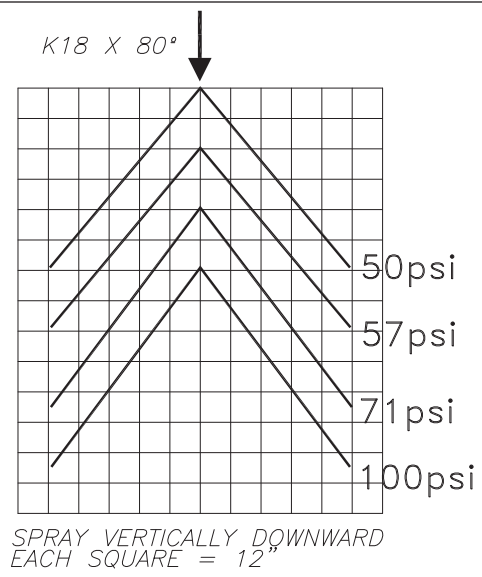
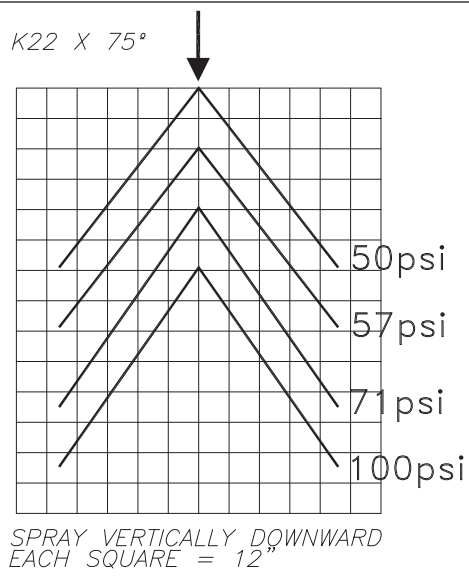

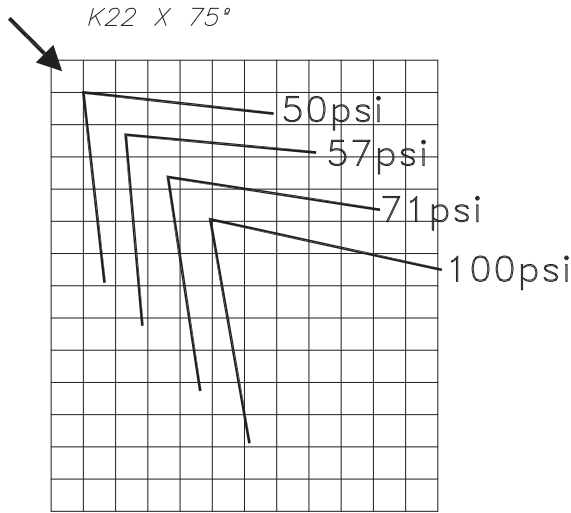

SPRAY AT 45° DOWNWARDS  
EACH SQUARE = 12"

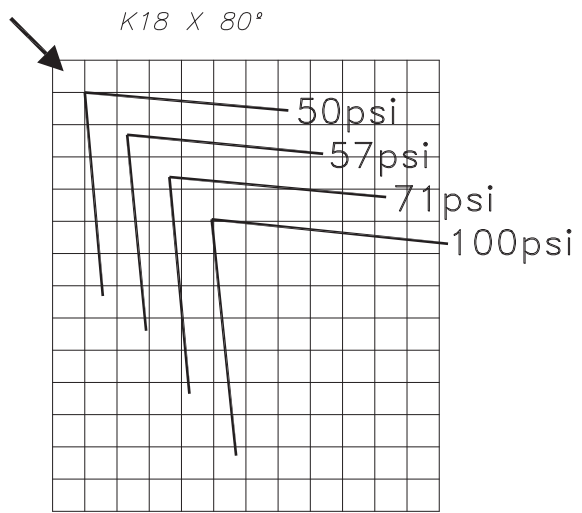

SPRAY AT 45° DOWNWARDS  
EACH SQUARE = 12"

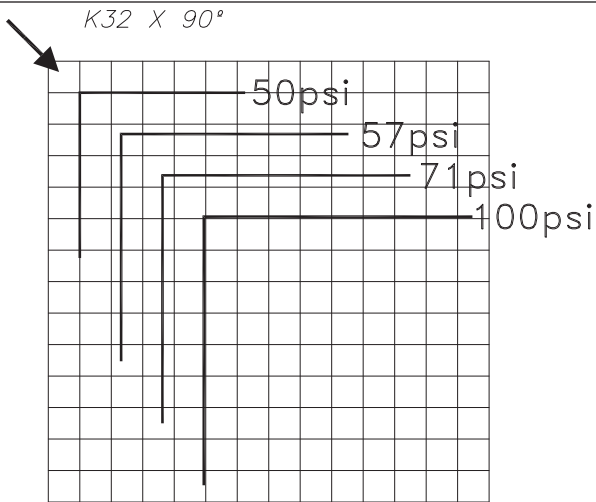

SPRAY AT 45° DOWNWARDS  
EACH SQUARE = 12"

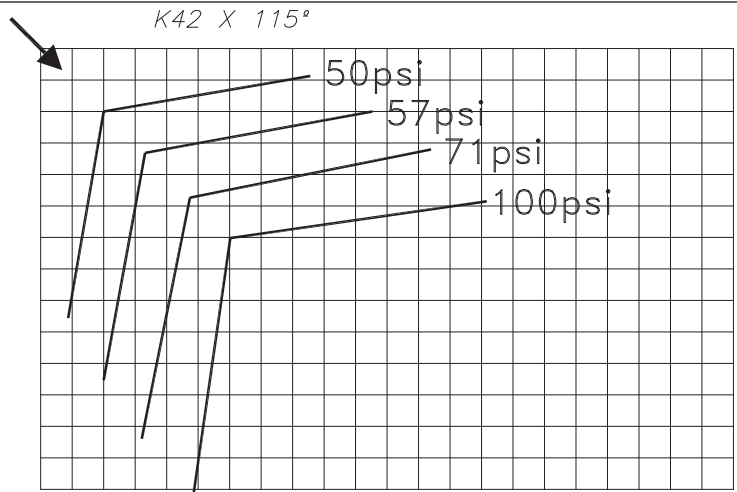

SPRAY AT 45° DOWNWARDS  
EACH SQUARE = 12"

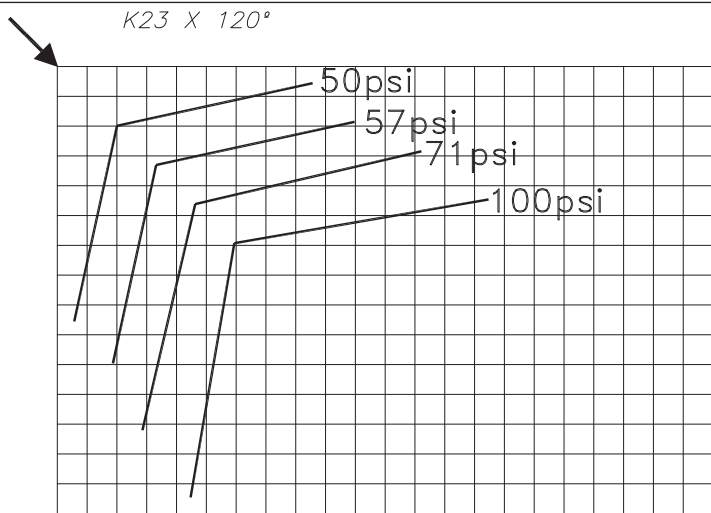

EACH SQUARE = 12"  
SPRAY AT 45° DOWNWARDS

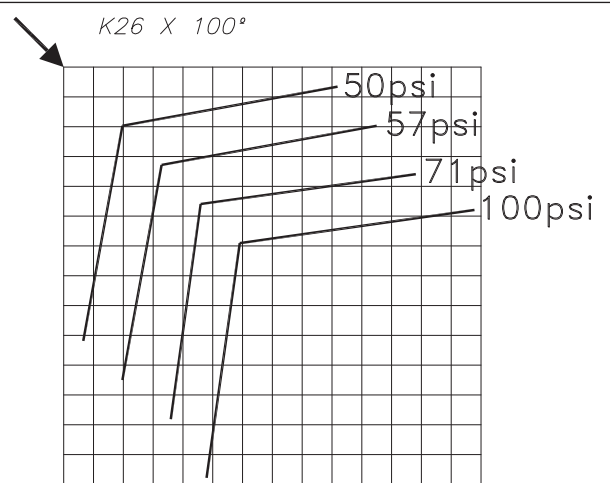

SPRAY AT 45° DOWNWARDS  
EACH SQUARE = 12"

*K22 X 75°*

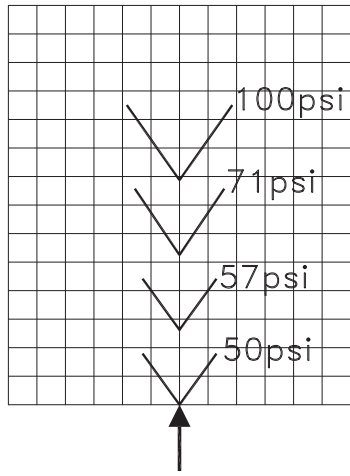

*SPRAY VERTICALLY UPWARD  
EACH SQUARE = 12"*

*K18 X 80°*

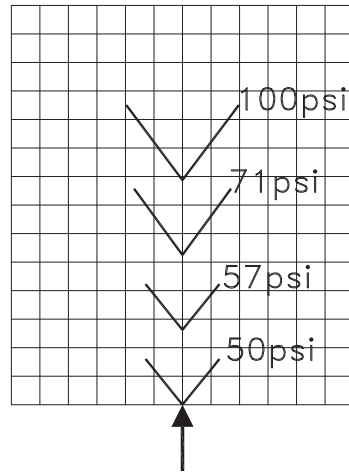

*SPRAY VERTICALLY UPWARD  
EACH SQUARE = 12"*

*K32 X 90°*

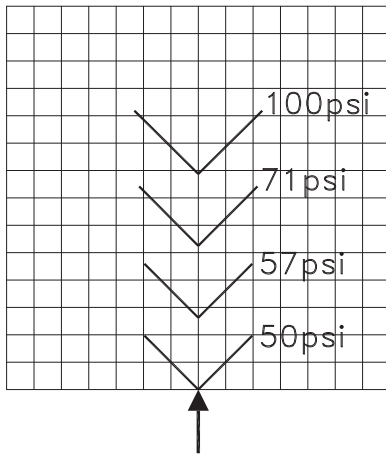

*SPRAY VERTICALLY UPWARD  
EACH SQUARE = 12"*

*K42 X 115°*

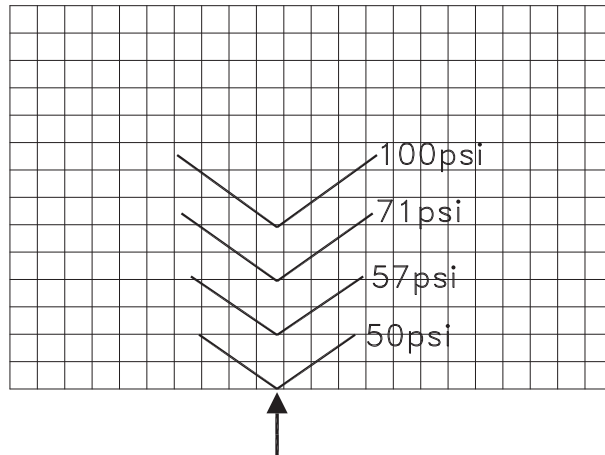

*SPRAY VERTICALLY UPWARD  
EACH SQUARE = 12"*

*K23 X 120°*

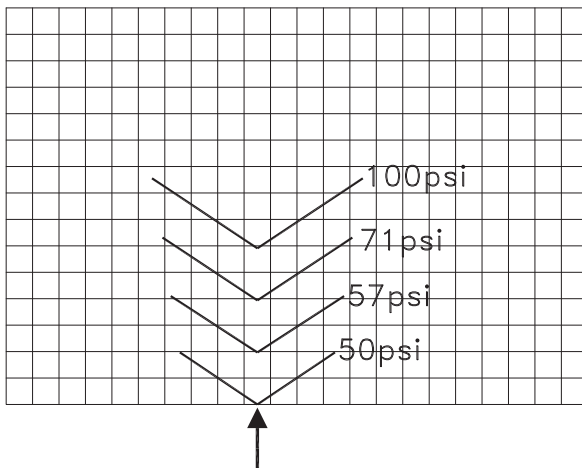

*SPRAY VERTICALLY UPWARD  
EACH SQUARE = 12"*

*K26 X 100°*

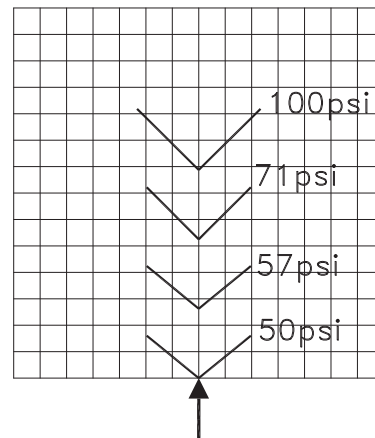

*SPRAY VERTICALLY UPWARD  
EACH SQUARE = 12"*

K22 X 75°

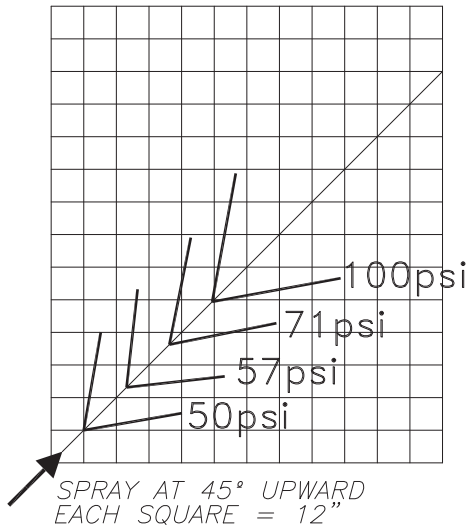

K18 X 80°

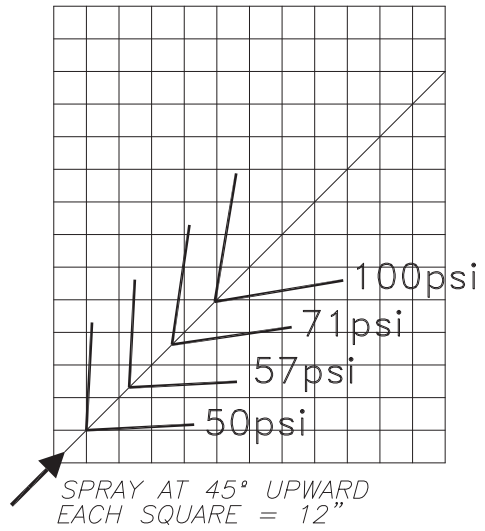

K32 X 90°

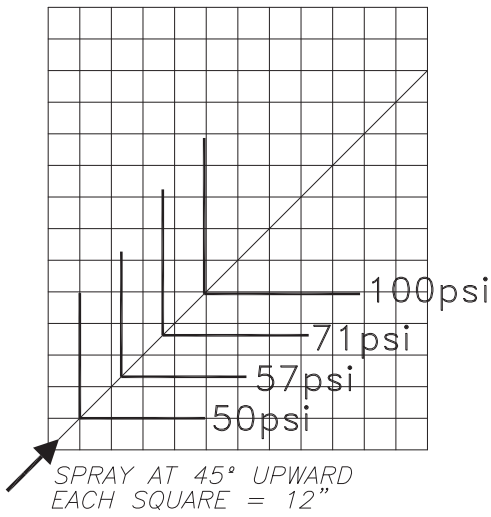

K42 X 115°

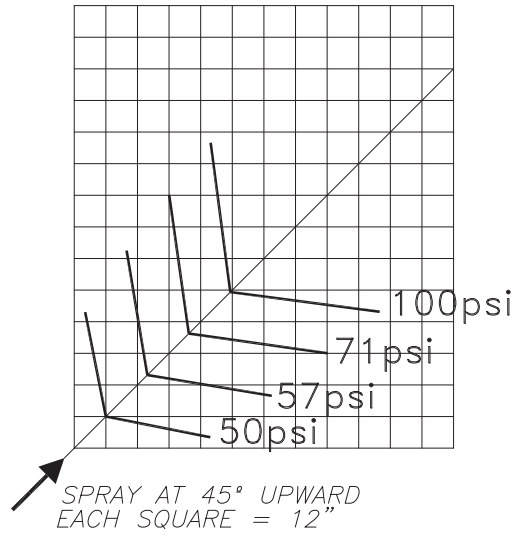

K23 X 120°

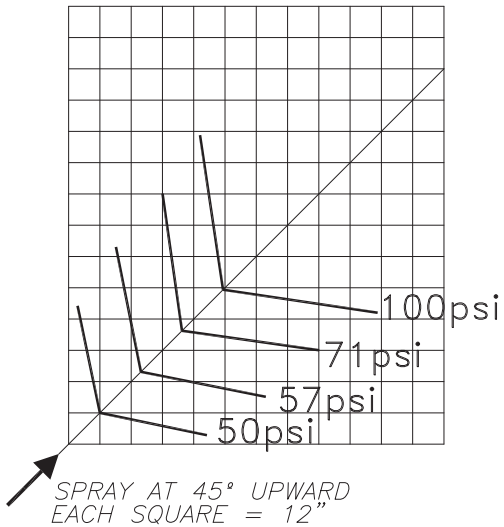

K26 X 100°

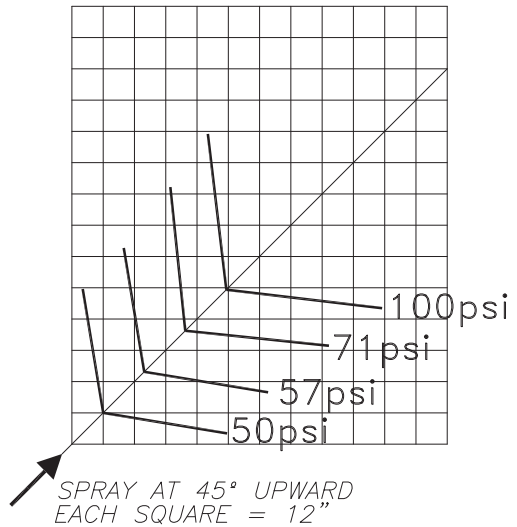

# Warning

Sprinklers Contained in this carton have been manufactured and tested in accordance with the standards of Underwriters Laboratories or other approving authorities. Specific information on approvals is provided in respective product bulletins.

Any alteration to the sprinkler after it leaves the factory including, but not limited to, painting, plating, coating or other modification, may render the sprinkler inoperative and will nullify applicable approvals.

## Important Precautions To Follow

1. Nozzles are to be installed in accordance with the latest published standards of the National Fire Protection Association and also with the provisions of governmental codes or ordinances whenever applicable.
2. Never replace a spray nozzles with an old style nozzle.
3. When replacing nozzles, be sure that the orifice sizes are the same.
4. Never install a nozzle after it has been dropped or damaged in any way. These nozzles should be returned to the factory for examination.
5. Never install nozzles in the fittings until the piping is in place on the ceiling. Nozzles may be damaged if screwed into the fittings when the lines are made up at the bench.
6. Never attach wiring ropes or fixtures to a nozzle or nozzle piping.
7. If pipe compound is used, apply to nozzle pipe thread only.
8. Store nozzles in a dry place. Prior to installation, nozzles should be maintained in the original cartons and packaging until used to minimize the potential for damage to sprinklers that would cause improper operation or non-operation.
9. Never apply paint or any other coating to nozzle

The equipment presented in this bulletin is to be installed in accordance with the latest published Standards of the National Fire Protection Association, Factory Mutual Research Corporation, or other similar organizations and also with the provisions of governmental codes or ordinances whenever applicable.

Products manufactured and distributed by Reliable have been protecting life and property for over 90 years, and are installed and serviced by the most highly qualified and reputable sprinkler contractors located throughout the United States, Canada and foreign countries.

Manufactured by

**Reliable**<sup>®</sup>

**Reliable Automatic Sprinkler Co., Inc.**

(800) 431-1588

(800) 848-6051

(914) 829-2042

[www.reliablesprinkler.com](http://www.reliablesprinkler.com)

Sales Offices

Sales Fax

Corporate Offices

Internet Address



Recycled  
Paper

Revision lines indicate updated or new data.

E.G. Printed in U.S.A. 07/14 P/N 9999970223